

RIVQUICK®

- 🇬🇧 Break stem and structural blind rivets
- 🇫🇷 Rivets à rupture de tige standards et haute résistance
- 🇩🇪 Blindniete und Blindnietwerkzeuge
- 🇮🇹 Rivetti a strappo e strutturali
- 🇪🇸 Remaches estándar y especiales

BÖLLHOFF

- 🇬🇧 Bollhoff the specialist in assembly techniques
- 🇫🇷 Böllhoff, le spécialiste des techniques d'assemblage
- 🇩🇪 Böllhoff, Ihr Spezialist in der Verbindungs- und Montagetechnik
- 🇮🇹 Böllhoff, lo specialista delle tecniche d'assemblaggio
- 🇪🇸 Böllhoff, el especialista en técnicas de fijación

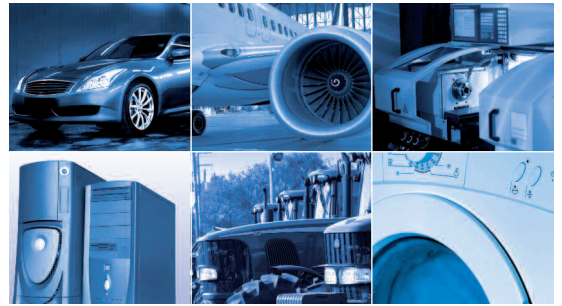

- 🇬🇧 Bollhoff, your industrial partner in more than 25 countries
- 🇫🇷 Böllhoff, votre partenaire industriel implanté dans plus de 25 pays
- 🇩🇪 Böllhoff, Ihr verlässlicher Partner in 25 Ländern
- 🇮🇹 Böllhoff, il Vostro partner industriale
- 🇪🇸 Böllhoff, proveedor industrial internacional



- 🇬🇧 Bollhoff, listens to your requests, searching for continuous innovation
- 🇫🇷 Böllhoff, à l'écoute de vos besoins, en quête de l'innovation permanente
- 🇩🇪 Böllhoff entwickelt für Sie maßgeschneiderte Lösungen mit dem Ziel kontinuierlicher Verbesserung
- 🇮🇹 Böllhoff ascolta i vostri bisogni e innova in modo permanente
- 🇪🇸 Böllhoff escucha sus demandas e innova permanentemente



- 🇬🇧 Bollhoff, service and responsiveness
- 🇫🇷 Böllhoff, le savoir-faire logistique et la réactivité
- 🇩🇪 Böllhoff, schneller Service
- 🇮🇹 Böllhoff, il servizio logistico e la reattività
- 🇪🇸 Böllhoff, el servicio, la reactividad





- 🇬🇧 Bollhoff, quality at all levels
- 🇫🇷 Böllhoff, partout la qualité au plus haut niveau
- 🇩🇪 Böllhoff, durchgängig hohe Qualität
- 🇮🇹 Böllhoff, la qualità a tutti i livelli
- 🇪🇸 Böllhoff, la calidad a todos los niveles







RIVQUICK®



-  RIVQUICK® Plus range
-  Gamme RIVQUICK® Plus
-  Produktprogramm RIVQUICK® Plus
-  Gamma RIVQUICK® Plus
-  Gama RIVQUICK® Plus





6



-  Standard break stem blind rivets
-  Rivets à rupture de tige standards
-  Standardblindniete
-  Rivetti a strappo standard
-  Remaches de vástago estándar





8



-  Special rivets
-  Rivets spéciaux
-  Spezialblindniete
-  Rivetti per applicazioni speciali
-  Remaches especiales





26



-  High strength and structural rivets
-  Rivets haute résistance et de structure
-  Hochfeste Blindniete
-  Rivetti ad alta resistenza e strutturali
-  Remaches de alta resistencia y estructurales

27



-  Riveting hand tools
-  Appareils de pose manuels
-  Blindnietwerkzeuge
-  Attrezzatura di posa
-  Equipos de colocación

35

Plus



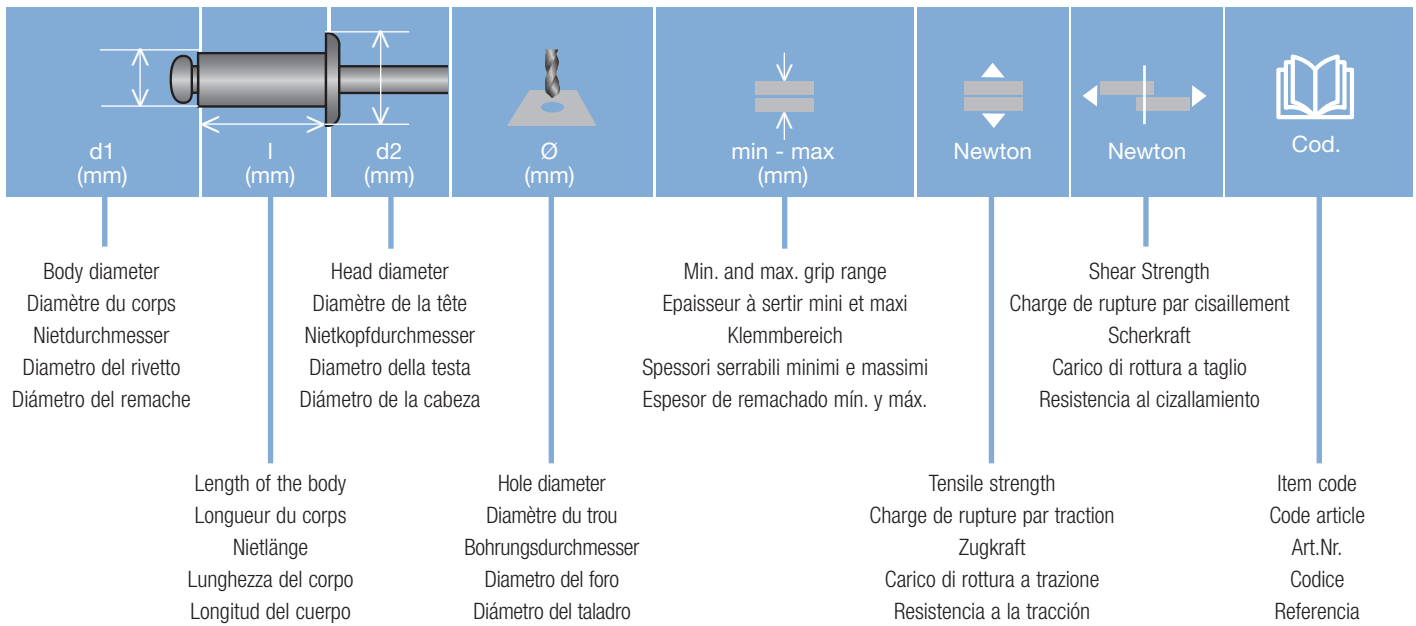

- 🇬🇧 ■ The rivets shown in this list conform to following specifications:
 EN ISO 15977 - EN ISO 15978 - EN ISO 15979 - EN ISO 15980 - EN ISO 15981 - EN ISO 15983
 ■ We reserve the right to modify, without notice, the items shown in our catalogue in order to improve quality.
 ■ For stock availability, please contact us.
- 🇫🇷 ■ Les rivets décrits dans ce document se rapportent aux normes suivantes :
 EN ISO 15977 - EN ISO 15978 - EN ISO 15979 - EN ISO 15980 - EN ISO 15981 - EN ISO 15983
 ■ La société se réserve le droit d'apporter des modifications, sans préavis, à ses produits pour en améliorer la qualité
 ■ Pour connaître la disponibilité des stocks, nous consulter.
- 🇩🇪 ■ Die in dieser Liste beschriebenen Blindnieten beziehen sich auf die folgenden Normen :
 EN ISO 15977 - EN ISO 15978 - EN ISO 15979 - EN ISO 15980 - EN ISO 15981 - EN ISO 15983
 ■ Böllhoff behält sich vor, die in diesem Katalog aufgeführten Produkte zur Qualitätssteigerung ohne vorherige Benachrichtigung anzupassen.
 ■ Bitte kontaktieren Sie uns bezüglich der Lagerverfügbarkeiten.
- 🇮🇹 ■ I rivetti a strappo descritti nel presente listino utilizzano come riferimento le seguenti norme :
 EN ISO 15977 - EN ISO 15978 - EN ISO 15979 - EN ISO 15980 - EN ISO 15981 - EN ISO 15983
 ■ La ditta si riserva la facoltà di apportare modifiche sui prodotti inseriti in questo listino atte a migliorarne la qualità senza preavviso alcuno.
 ■ Consultateci per conoscere la nostra disponibilità di stock.
- 🇪🇸 ■ Los remaches descritos en esta lista responden a las siguientes normas :
 EN ISO 15977 - EN ISO 15978 - EN ISO 15979 - EN ISO 15980 - EN ISO 15981 - EN ISO 15983
 ■ La empresa se reserva el derecho a hacer modificaciones, sin previo aviso, sobre los productos incluidos en este catálogo, con el fin de mejorar la calidad.
 ■ Para conocer la disponibilidad de stock, consúltenos.

RIVQUICK® – Selection guide - Guide de sélection - Anleitung - Guida alla Selezione - Guía de selección

Material - Matière - Materialien - Materiale - Material										Head - Tête - Kopf - Testa - Cabeza								
	alu	steel	steel	steel	stainless steel	stainless steel	alu	alu	alu	stainless steel		dome		countersunk		large flange		extra-large
	alu	acier	acier	acier	inox	inox	alu	alu	alu	inox		plate		fraisée		large		extra-large
	Aluminium	Stahl	Stahl	Stahl	Edelstahl	Edelstahl	Aluminium	Aluminium	Aluminium	Edelstahl		Flachrundkopf		Senkkopf		Großer Kopf		Extra großer Kopf
	allu	acciaio	acciaio	acciaio	inox	inox	allu	allu	allu	inox		tonda		svasata		larga		extra-larga
	alu	acero	acero	acero	inox	inox	alu	alu	alu	inox		alomada		fresada		grande		extra-grande

RIVQUICK® Plus

	•										•							
					•						•							
	•										•							
			•								•							

Standard rivets - Rivets standards - Standardblindniete - Rivetti standard - Remaches estándar

	•										•							
	•											•						
	•												•					
	•																•	
			•								•							
			•										•					
					•						•							
								•			•							
									•		•							

Peel type rivets - Rivets éclatés - Spreizblindniete - Rivetti a fiore - Remaches de flor

	•										•							
--	---	--	--	--	--	--	--	--	--	--	---	--	--	--	--	--	--	--

Slotted rivets - Rivets fendus - Presslaschenblindniete - Rivetti 3 ali - Remaches de trébol

							•				•							
--	--	--	--	--	--	--	---	--	--	--	---	--	--	--	--	--	--	--

Sealed type rivets - Rivets étanches - Becher-Dichtblindniete - Rivetti stagni - Remaches estancos

	•										•							
										•	•							

Multigrip - Multiserrage - Mehrbereichsblindniete - Multigrip - Multigrip

	•										•							
	•																	•

Coloured rivets - Rivets couleur - Farbige Blindniete - Rivetti colorati - Remaches de colores

	•										•							
--	---	--	--	--	--	--	--	--	--	--	---	--	--	--	--	--	--	--

Inox A4 - Inox A4 - Edelstahl A4 - Inox A4 - Inox A4

					•						•							
--	--	--	--	--	---	--	--	--	--	--	---	--	--	--	--	--	--	--



7

7

7

7

8

10

11

12

13

14

15

16

17

18

19

20

21

22

23

23

24

25

RIVQUICK® Plus



- 🇬🇧 This is the heart of the RIVQUICK® range.
These items are shipped within 24 hours of your order being placed.
- 🇫🇷 C'est le cœur de gamme RIVQUICK®.
Ces articles sont expédiés dans les 24h qui suivent la saisie de votre commande.
- 🇩🇪 Das Kernprogramm unseres RIVQUICK® Angebots.
Diese Elemente werden innerhalb von 24 Stunden ausgeliefert.
- 🇮🇹 Il cuore della gamma RIVQUICK®.
Gli articoli di questa gamma sono disponibili alla spedizione entro le successiva 24 ore dal vostro ordine.
- 🇪🇸 Esta es la gama RIVQUICK® principal.
Estos artículos se envían en un plazo máximo de 24hrs. una vez confirmada la recepción de su pedido.

Plus

RIVQUICK® – Standard rivets - Rivets standards - Standardblindniete - Rivetti standard - Remaches estándar

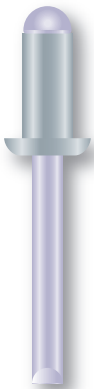

RIVQUICK® Plus



English	Français	Deutsch	Italiano	Español
Dome head	Tête plate	Flachrundkopf	Testa tonda	Cabeza alomada
Aluminium Al Mg 3,5	Aluminium Al Mg 3,5	Aluminium Al Mg 3,5	Alluminio Al Mg 3,5	Aluminio Al Mg 3,5
Steel zinc plated	Acier zingué	Stahl verzinkt	Acciaio zincato	Acero cincado

d1 (mm)	l (mm)	d2 (mm)	Ø (mm)	min - max (mm)	N	N	Cod.	
3,0	6,0	6,0	3,1 - 3,2	1,0 - 3,5	720	620	220 611 30060	■
	8,0			1,0 - 3,5			220 611 32060	■
3,2	8,0	6,0	3,3 - 3,4	3,5 - 5,5	900	670	220 611 32080	■
	10,0			5,5 - 7,0			220 611 32100	■
	6,0			1,0 - 3,0			220 611 40060	■
4,0	8,0	8,0	4,1 - 4,2	3,0 - 5,0	1 560	1 050	220 611 40080	■
	10,0			5,0 - 6,5			220 611 40100	■
	12,0			6,5 - 8,5			220 611 40120	■
	14,0			8,5 - 10,5			220 611 40140	▲
	16,0			10,5 - 12,5			220 611 40160	▲
	8,0			2,5 - 4,0			220 611 48080	▲
4,8	10,0	9,5	4,9 - 5,0	4,0 - 6,0	2 230	1 700	220 611 48100	▲
	12,0			6,0 - 8,0			220 611 48120	▲
	14,0			8,0 - 10,0			220 611 48140	▲
	16,0			10,0 - 12,0			220 611 48160	▲
	20,0			14,0 - 16,0			220 611 48200	●
6,0	12,0	12,0	6,1 - 6,2	5,0 - 7,0	3 100	2 550	220 611 60120	▲
6,4	12,0	13,0	6,5 - 6,7	4,0 - 6,0	4 100	2 800	220 611 64120	●



x 1000	■
x 500	▲
x 250	●

Plus

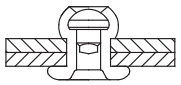

RIVQUICK® Plus
24H

	English	Français	Deutsch	Italiano	Español				
	Dome head	Tête plate	Flachrundkopf	Testa tonda	Cabeza alomada				
	Stainless steel A2	Inox A2	Edelstahl A2	Inox A2	Inox A2				
	Stainless steel A2	Inox A2	Edelstahl A2	Inox A2	Inox A2				
	d1 (mm)	l (mm)	d2 (mm)	Ø (mm)	min - max (mm)	N	N	Cod.	
3,2	8,0	6,0	6,0	3,3 - 3,4	3,0 - 5,0	2 500	1 900	220 331 32080	■
		6,0			1,0 - 2,5			220 331 40060	■
	10,0	8,0	8,0	4,1 - 4,2	2,5 - 4,5	3 650	2 900	220 331 40080	■
		13,0			4,5 - 6,5			220 331 40100	■
4,0	10,0	8,0	8,0	4,1 - 4,2	4,5 - 6,5	3 650	2 900	220 331 40130	■
		13,0			7,5 - 9,5			220 331 40130	■
	20,0	9,5	9,5	4,9 - 5,0	1,5 - 4,0	5 340	4 230	220 331 48080	▲
4,8	10,0	10,0	9,5	4,9 - 5,0	4,0 - 6,0	5 340	4 230	220 331 48100	▲
	20,0				13,0 - 16,0			220 331 48200	▲

RIVQUICK® Varigrip – Multigrip - Multiserrage - Mehrbereichsblindniete - Multigrip - Multigrip

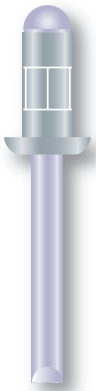

RIVQUICK® Plus
24H

	English	Français	Deutsch	Italiano	Español				
	Dome head	Tête plate	Flachrundkopf	Testa tonda	Cabeza alomada				
	Aluminium Al Mg 3,5	Aluminium Al Mg 3,5	Aluminium Al Mg 3,5	Alluminio Al Mg 3,5	Aluminio Al Mg 3,5				
	Steel zinc plated	Acier zingué	Stahl verzinkt	Acciaio zincato	Acero cincado				
	d1 (mm)	l (mm)	d2 (mm)	Ø (mm)	min - max (mm)	N	N	Cod.	
3,2	8,0	6,0	6,0	3,3 - 3,4	1,0 - 4,8	900	600	220 211 32080	■
		8,0			4,1 - 4,2	1,2 - 6,4	1 500	950	220 211 40100
4,0	10,0	10,0	8,0	4,1 - 4,2	1,6 - 6,4	2 000	1 320	220 211 48110	▲



RIVQUICK® Plus
24H

	English	Français	Deutsch	Italiano	Español				
	Dome head	Tête plate	Flachrundkopf	Testa tonda	Cabeza alomada				
	Steel zinc plated	Acier zingué	Stahl verzinkt	Acciaio zincato	Acero cincado				
	Steel zinc plated	Acier zingué	Stahl verzinkt	Acciaio zincato	Acero cincado				
	d1 (mm)	l (mm)	d2 (mm)	Ø (mm)	min - max (mm)	N	N	Cod.	
3,2	12,0	7,6	7,6	3,3 - 3,4	1,0 - 7,0	1 400	1 000	220 221 32120	■
		8,4			4,1 - 4,2	2,0 - 8,0	2 000	1 500	220 221 40130
4,0	13,0	10,1	8,4	4,1 - 4,2	1,5 - 6,3	2 900	2 700	220 221 48110	▲

x 1000	■
x 500	▲
x 250	●

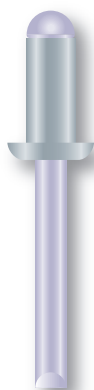

English	Français	Deutsch	Italiano	Español
Dome head	Tête plate	Flachrundkopf	Testa tonda	Cabeza alomada
Aluminium Al Mg 3,5	Aluminium Al Mg 3,5	Aluminium Al Mg 3,5	Alluminio Al Mg 3,5	Aluminio Al Mg 3,5
Steel zinc plated	Acier zingué	Stahl verzinkt	Acciaio zincato	Acero cincado

d1 (mm)	l (mm)	d2 (mm)	Ø (mm)	min - max (mm)	N	N	Cod.
2,4	5,0	5,0	2,5 - 2,55	0,5 - 2,0	550	400	221 611 24050
	6,0			1,0 - 3,0			221 611 24060
	7,0			2,5 - 4,5			221 611 24070
	8,0			4,0 - 6,0			221 611 24080
	10,0			6,0 - 8,0			221 611 24100
	12,0			8,0 - 10,0			221 611 24120
3,0	5,0	6,5	3,1 - 3,2	0,5 - 2,0	950	600	221 611 30050
	6,0			1,0 - 3,0			221 611 30060
	7,0			2,0 - 4,0			221 611 30070
	8,0			3,0 - 5,0			221 611 30080
	9,0			4,0 - 6,0			221 611 30090
	10,0			5,0 - 7,0			221 611 30100
	11,0			6,0 - 8,0			221 611 30110
	12,0			7,0 - 9,0			221 611 30120
	14,0			9,0 - 11,0			221 611 30140
16,0	11,0 - 13,0	221 611 30160					
	18,0			13,0 - 15,0			221 611 30180
3,2	5,0	6,5	3,3 - 3,4	0,5 - 2,0	1 000	750	221 611 32050
	6,0			1,0 - 3,0			221 611 32060
	7,0			2,0 - 4,0			221 611 32070
	8,0			3,0 - 5,0			221 611 32080
	9,0			4,0 - 6,0			221 611 32090
	10,0			5,0 - 7,0			221 611 32100
	11,0			6,0 - 8,0			221 611 32110
	12,0			7,0 - 9,0			221 611 32120
	14,0			9,0 - 11,0			221 611 32140
	16,0			11,0 - 13,0			221 611 32160
	18,0			13,5 - 15,0			221 611 32180
	20,0			14,0 - 17,0			221 611 32200
4,0	5,0	8,0	4,1 - 4,2	0,5 - 2,0	1 750	1 200	221 611 40050
	6,0			1,0 - 2,5			221 611 40060
	7,0			2,0 - 3,5			221 611 40070
	8,0			3,0 - 4,5			221 611 40080
	9,0			4,0 - 5,5			221 611 40090
	10,0			5,0 - 6,5			221 611 40100
	11,0			6,0 - 7,5			221 611 40110
	12,0			7,0 - 8,5			221 611 40120
	14,0			8,0 - 10,5			221 611 40140
	16,0			10,0 - 12,5			221 611 40160
	18,0			12,0 - 14,5			221 611 40180
	20,0			14,0 - 16,5			221 611 40200
	22,0			16,0 - 18,5			221 611 40220
	24,0			18,0 - 20,5			221 611 40240
	26,0			20,0 - 22,5			221 611 40260
28,0	22,0 - 24,5	221 611 40280					
30,0	24,0 - 26,5	221 611 40300					
	35,0			27,0 - 31,5			221 611 40350

The references marked in blue are available from stock - Unless sold in the meantime.

Les articles avec code article en bleu sont tenus en stock - sauf vente entre-temps.

Die blau markierten Artikel sind ab Lager lieferbar - falls nicht zwischenzeitlich verkauft.

I riferimenti contrassegnati in blu sono disponibili a magazzino - Salvo venduto.

Las referencias marcadas en azul están disponibles en stock - salvo venta.

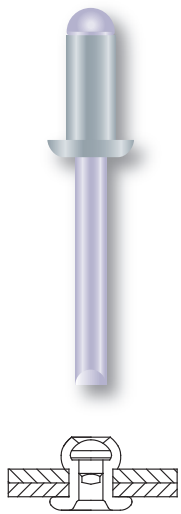

English	Français	Deutsch	Italiano	Español
Dome head	Tête plate	Flachrundkopf	Testa tonda	Cabeza alomada
Aluminium Al Mg 3,5	Aluminium Al Mg 3,5	Aluminium Al Mg 3,5	Alluminio Al Mg 3,5	Aluminio Al Mg 3,5
Steel zinc plated	Acier zingué	Stahl verzinkt	Acciaio zincato	Acero cincado

	d1 (mm)	l (mm)	d2 (mm)	Ø (mm)	min - max (mm)	N	N	Cod.
4,8		6,0	9,5	4,9 - 5,0	0,5 - 2,0	2 600	1 850	221 611 48060
		7,0			221 611 48070			
		8,0			221 611 48080			
		9,0			221 611 48090			
		10,0			221 611 48100			
		11,0			221 611 48110			
		12,0			221 611 48120			
		14,0			221 611 48140			
		16,0			221 611 48160			
		18,0			221 611 48180			
		20,0			221 611 48200			
		22,0			221 611 48220			
		24,0			221 611 48240			
		26,0			221 611 48260			
		28,0			221 611 48280			
		30,0			221 611 48300			
	35,0	221 611 48350						
	40,0	221 611 48400						
	45,0	221 611 48450						
	50,0	221 611 48500						
5,0		6,0	9,5	5,1 - 5,2	0,5 - 2,0	2 700	2 000	221 611 50060
		8,0			221 611 50080			
		10,0			221 611 50100			
		12,0			221 611 50120			
		14,0			221 611 50140			
		16,0			221 611 50160			
		18,0			221 611 50180			
		20,0			221 611 50200			
		22,0			221 611 50220			
		24,0			221 611 50240			
		26,0			221 611 50260			
	28,0	221 611 50280						
	30,0	221 611 50300						
6,0		8,0	12,0	6,1 - 6,3	1,0 - 3,0	4 400	2 800	221 611 60080
		10,0			221 611 60100			
		12,0			221 611 60120			
		14,0			221 611 60140			
		16,0			221 611 60160			
		18,0			221 611 60180			
		20,0			221 611 60200			
		22,0			221 611 60220			
		26,0			221 611 60260			
		30,0			221 611 60300			
		35,0			221 611 60350			
	40,0	221 611 60400						
6,4		10,0	13,0	6,5 - 6,7	2,0 - 5,0	4 950	3 200	221 611 64100
		12,0			221 611 64120			
		16,0			221 611 64160			
		18,0			221 611 64180			
		22,0			221 611 64220			
		26,0			221 611 64260			
		30,0			221 611 64300			
	35,0	221 611 64350						
	40,0	221 611 64400						
7,8		15,0	16,0	7,9 - 8,1	4,0 - 9,0	6 500	5 250	221 611 78150
		18,0			221 611 78180			
		22,0			221 611 78220			
		26,0			221 611 78260			
		30,0			221 611 78300			
	35,0	221 611 78350						

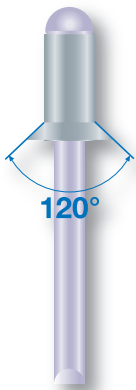

English	Français	Deutsch	Italiano	Español
Countersunk head	Tête fraisée	Senkkopf	Testa svasata	Cabeza fresada
Aluminium Al Mg 3,5	Aluminium Al Mg 3,5	Aluminium Al Mg 3,5	Alluminio Al Mg 3,5	Aluminio Al Mg 3,5
Steel zinc plated	Acier zingué	Stahl verzinkt	Acciaio zincato	Acero cincado

d1 (mm)	l (mm)	d2 (mm)	Ø (mm)	min - max (mm)	N	N	Cod.
2,4	6,0	5,0	2,5 - 2,55	2,0 - 4,0	550	400	221 312 24060
	8,0			4,0 - 6,0			221 312 24080
	10,0			6,0 - 8,0			221 312 24100
3,0	7,0	6,0	3,1 - 3,2	2,0 - 4,0	950	600	221 312 30070
	9,0			4,0 - 6,0			221 312 30090
	11,0			6,0 - 8,0			221 312 30110
3,2	7,0	6,0	3,3 - 3,4	2,0 - 4,0	1 000	750	221 312 32070
	9,0			4,0 - 6,0			221 312 32090
	11,0			6,0 - 8,0			221 312 32110
4,0	7,0	7,5	4,1 - 4,2	2,5 - 4,0	1 750	1 200	221 312 40070
	9,0			3,5 - 6,0			221 312 40090
	11,0			5,5 - 8,0			221 312 40110
	12,0			7,5 - 9,0			221 312 40120
	14,0			8,5 - 11,0			221 312 40140
	16,0			10,5 - 13,0			221 312 40160
	18,0			12,5 - 15,0			221 312 40180
20,0	14,5 - 17,0	221 312 40200					
4,8	7,0	9,0	4,9 - 5,0	2,5 - 4,0	2 600	1 850	221 312 48070
	9,0			3,5 - 5,0			221 312 48090
	11,0			4,5 - 7,0			221 312 48110
	12,0			6,5 - 8,0			221 312 48120
	14,0			7,5 - 10,0			221 312 48140
	16,0			9,5 - 12,0			221 312 48160
	18,0			11,5 - 14,0			221 312 48180
	20,0			13,5 - 16,0			221 312 48200
	26,0			19,5 - 22,0			221 312 48260
	30,0			23,5 - 26,0			221 312 48300

The references marked in blue are available from stock - Unless sold in the meantime.

Les articles avec code article en bleu sont tenus en stock - sauf vente entre-temps.

Die blau markierten Artikel sind ab Lager lieferbar - falls nicht zwischenzeitlich verkauft.

I riferimenti contrassegnati in blu sono disponibili a magazzino - Salvo venduto.

Las referencias marcadas en azul están disponibles en stock - salvo venta.

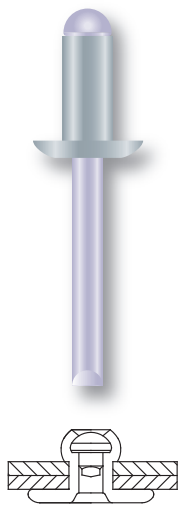

English	Français	Deutsch	Italiano	Español
Large head	Tête large	Großer Kopf	Testa larga	Cabeza grande
Aluminium Al Mg 3,5	Aluminium Al Mg 3,5	Aluminium Al Mg 3,5	Alluminio Al Mg 3,5	Aluminio Al Mg 3,5
Steel zinc plated	Acier zingué	Stahl verzinkt	Acciaio zincato	Acero cincado

d1 (mm)	l (mm)	d2 (mm)	Ø (mm)	min - max (mm)	N	N	Cod.
4,0	8,0	10,0	4,1 - 4,2	2,0 - 4,0	1 750	1 200	221 314 40080
	10,0			5,0 - 6,5			221 314 40100
	12,0			7,0 - 8,5			221 314 40120
	14,0			8,0 - 10,5			221 314 40140
	16,0			10,0 - 12,5			221 314 40160
	20,0			13,0 - 16,5			221 314 40200
4,8	8,0	14,0	4,9 - 5,0	2,5 - 4,0	2 600	1 850	221 314 48080
	10,0			4,5 - 6,0			221 314 48100
	12,0			5,5 - 8,0			221 314 48120
	14,0			7,5 - 10,0			221 314 48140
	16,0			9,5 - 12,0			221 314 48160
	18,0			11,5 - 14,0			221 314 48180
	20,0			13,5 - 16,0			221 314 48200
	24,0			17,5 - 20,0			221 314 48240
	26,0			19,5 - 22,0			221 314 48260
	30,0			23,5 - 26,0			221 314 48300
	35,0			25,5 - 31,0			221 314 48350
	40,0			29,5 - 36,0			221 314 48400



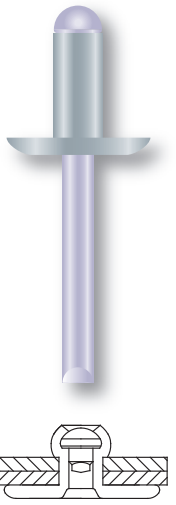

English	Français	Deutsch	Italiano	Español
Extra-large head	Tête extra-large	Extra großer Kopf	Testa extra-larga	Cabeza extra-grande
Aluminium Al Mg 3,5	Aluminium Al Mg 3,5	Aluminium Al Mg 3,5	Alluminio Al Mg 3,5	Aluminio Al Mg 3,5
Steel zinc plated	Acier zingué	Stahl verzinkt	Acciaio zincato	Acero cincado

d1 (mm)	l (mm)	d2 (mm)	Ø (mm)	min - max (mm)	N	N	Cod.
3,2	8,0	10,0	3,3 - 3,4	3,0 - 5,0	1 000	750	221 316 32080
	10,0			5,0 - 7,0			221 316 32100
	12,0			7,0 - 9,0			221 316 32120
	14,0			9,0 - 11,0			221 316 32140
	16,0			11,0 - 13,0			221 316 32160
4,0	8,0	12,0	4,1 - 4,2	2,0 - 4,5	1 750	1 200	221 316 40080
	10,0			5,0 - 6,5			221 316 40100
	12,0			7,0 - 8,5			221 316 40120
	14,0			8,0 - 10,5			221 316 40140
	16,0			10,0 - 12,5			221 316 40160
20,0	13,0 - 16,5	221 316 40200					
4,8	10,0	16,0	4,9 - 5,0	4,5 - 6,0	2 600	1 850	221 316 48100
	12,0			5,5 - 8,0			221 316 48120
	14,0			7,5 - 10,0			221 316 48140
	16,0			9,5 - 12,0			221 316 48160
	18,0			11,5 - 14,0			221 316 48180
	20,0			13,5 - 16,0			221 316 48200
	24,0			15,5 - 18,0			221 316 48240
	26,0			17,5 - 20,0			221 316 48260
	30,0			23,5 - 26,0			221 316 48300
	35,0			25,5 - 31,0			221 316 48350
40,0	30,5 - 36,0	221 316 48400					

The references marked in blue are available from stock - Unless sold in the meantime.

Les articles avec code article en bleu sont tenus en stock - sauf vente entre-temps.

Die blau markierten Artikel sind ab Lager lieferbar - falls nicht zwischenzeitlich verkauft.

I riferimenti contrassegnati in blu sono disponibili a magazzino - Salvo venduto.

Las referencias marcadas en azul están disponibles en stock - salvo venta.

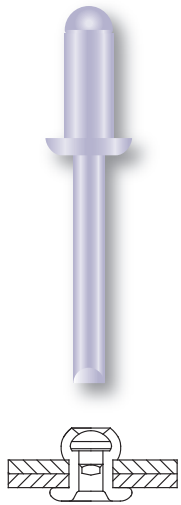

English	Français	Deutsch	Italiano	Español
Dome head	Tête plate	Flachrundkopf	Testa tonda	Cabeza alomada
Steel zinc plated	Acier zingué	Stahl verzinkt	Acciaio zincato	Acero cincado
Steel zinc plated	Acier zingué	Stahl verzinkt	Acciaio zincato	Acero cincado

	 d1 (mm)	 l (mm)	 d2 (mm)	 Ø (mm)	 min - max (mm)	 N	 N	 Cod.
3,0	6,0	6,5	3,1 - 3,2	0,5 - 3,0	1 400	1 050	221 321 30060	
	7,0			3,0 - 4,0			221 321 30070	
	8,0			4,0 - 5,0			221 321 30080	
	9,0			5,0 - 6,0			221 321 30090	
	10,0			6,0 - 7,0			221 321 30100	
	12,0			7,0 - 9,0			221 321 30120	
3,2	6,0	6,5	3,3 - 3,4	0,5 - 3,0	1 500	1 100	221 321 32060	
	7,0			3,0 - 4,0			221 321 32070	
	8,0			4,0 - 5,0			221 321 32080	
	9,0			5,0 - 6,0			221 321 32090	
	10,0			6,0 - 7,0			221 321 32100	
	11,0			7,0 - 8,0			221 321 32110	
	12,0			8,0 - 9,0			221 321 32120	
4,0	6,0	8,0	4,1 - 4,2	1,0 - 2,5	2 500	1 800	221 321 40060	
	7,0			2,0 - 3,5			221 321 40070	
	8,0			3,0 - 4,5			221 321 40080	
	9,0			4,0 - 5,5			221 321 40090	
	10,0			5,0 - 6,5			221 321 40100	
	11,0			6,0 - 7,5			221 321 40110	
	12,0			7,0 - 8,5			221 321 40120	
	14,0			8,0 - 10,5			221 321 40140	
	16,0			10,0 - 12,5			221 321 40160	
	18,0			12,0 - 14,5			221 321 40180	
	20,0			14,0 - 16,5			221 321 40200	
24,0	16,0 - 20,5	221 321 40240						
30,0	20,0 - 26,5	221 321 40300						
4,8	6,0	9,5	4,9 - 5,0	0,5 - 2,0	3 700	2 900	221 321 48060	
	7,0			1,5 - 3,0			221 321 48070	
	8,0			2,5 - 4,0			221 321 48080	
	9,0			3,5 - 5,0			221 321 48090	
	10,0			4,5 - 6,0			221 321 48100	
	11,0			5,5 - 7,0			221 321 48110	
	12,0			6,5 - 8,0			221 321 48120	
	14,0			7,5 - 10,0			221 321 48140	
	16,0			9,5 - 12,0			221 321 48160	
	18,0			11,5 - 14,0			221 321 48180	
	20,0			13,5 - 16,0			221 321 48200	
	24,0			15,5 - 20,0			221 321 48240	
	26,0			17,5 - 22,0			221 321 48260	
	30,0			19,5 - 26,0			221 321 48300	
35,0	25,0 - 31,0	221 321 48350						
40,0	31,0 - 36,0	221 321 48400						
6,0	8,0	12,0	6,1 - 6,3	1,0 - 3,0	6 000	4 300	221 321 60080	
	10,0			2,0 - 3,5			221 321 60100	
	12,0			3,5 - 7,0			221 321 60120	
	15,0			6,5 - 10,0			221 321 60150	
	18,0			9,5 - 13,0			221 321 60180	
	22,0			12,5 - 17,0			221 321 60220	
	26,0			16,5 - 21,0			221 321 60260	
	30,0			20,5 - 25,0			221 321 60300	
6,4	8,0	13,0	6,5 - 6,7	1,0 - 3,0	6 500	4 900	221 321 64080	
	10,0			2,0 - 5,0			221 321 64100	
	12,0			3,5 - 7,0			221 321 64120	
	15,0			6,5 - 10,0			221 321 64150	
	18,0			9,5 - 13,0			221 321 64180	
	22,0			12,5 - 17,0			221 321 64220	
	26,0			16,5 - 21,0			221 321 64260	
	30,0			20,5 - 25,0			221 321 64300	

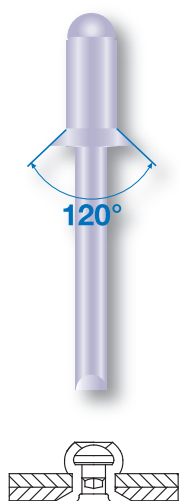

English	Français	Deutsch	Italiano	Español
Countersunk head	Tête fraisée	Senkkopf	Testa svasata	Cabeza fresada
Steel zinc plated	Acier zingué	Stahl verzinkt	Acciaio zincato	Acero cincado
Steel zinc plated	Acier zingué	Stahl verzinkt	Acciaio zincato	Acero cincado

d1 (mm)	l (mm)	d2 (mm)	Ø (mm)	min - max (mm)	N	N	Cod.
3,2	8,0	6,0	3,3 - 3,4	3,0 - 5,0	1 500	1 100	221 322 32080
	10,0			5,0 - 7,0			221 322 32100
	12,0			7,0 - 9,0			221 322 32120
4,0	8,0	7,5	4,1 - 4,2	2,5 - 4,5	2 500	1 800	221 322 40080
	10,0			4,5 - 6,5			221 322 40100
	12,0			6,5 - 8,5			221 322 40120
	14,0			8,5 - 10,5			221 322 40140
4,8	10,0	9,0	4,9 - 5,0	4,0 - 6,0	3 700	2 900	221 322 48100
	12,0			6,0 - 8,0			221 322 48120
	14,0			7,0 - 9,0			221 322 48140
	16,0			7,5 - 11,0			221 322 48160
	20,0			11,0 - 15,0			221 322 48200

The references marked in blue are available from stock - Unless sold in the meantime.

Les articles avec code article en bleu sont tenus en stock - sauf vente entre-temps.

Die blau markierten Artikel sind ab Lager lieferbar - falls nicht zwischenzeitlich verkauft.

I riferimenti contrassegnati in blu sono disponibili a magazzino - Salvo venduto.

Las referencias marcadas en azul están disponibles en stock - salvo venta.

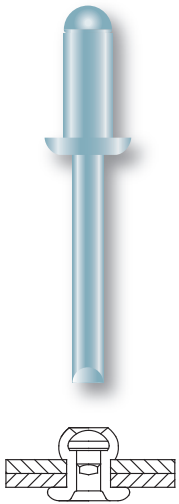

English	Français	Deutsch	Italiano	Español
Dome head	Tête plate	Flachrundkopf	Testa tonda	Cabeza alomada
Stainless steel A2	Inox A2	Edelstahl A2	Inox A2	Inox A2
Stainless steel A2	Inox A2	Edelstahl A2	Inox A2	Inox A2

d1 (mm)	l (mm)	d2 (mm)	Ø (mm)	min - max (mm)	N	N	Cod.
3,0	6,0	6,5	3,1 - 3,2	1,0 - 3,0	2 100	1 900	221 331 30060
	8,0			3,0 - 5,0			221 331 30080
	10,0			5,0 - 7,0			221 331 30100
	12,0			7,0 - 8,5			221 331 30120
3,2	6,0	6,5	3,3 - 3,4	0,5 - 3,0	2 400	1 900	221 331 32060
	8,0			3,0 - 5,0			221 331 32080
	10,0			4,0 - 6,0			221 331 32100
	12,0			6,0 - 8,0			221 331 32120
4,0	6,0	8,0	4,1 - 4,2	1,0 - 3,5	4 000	3 200	221 331 40060
	8,0			2,0 - 4,5			221 331 40080
	10,0			4,0 - 6,5			221 331 40100
	12,0			6,5 - 8,0			221 331 40120
	14,0			7,0 - 9,5			221 331 40140
	16,0			9,0 - 12,0			221 331 40160
4,8	20,0	9,5	4,9 - 5,0	12,0 - 15,5	5 800	4 700	221 331 40200
	8,0			2,5 - 4,0			221 331 48080
	10,0			4,0 - 6,0			221 331 48100
	12,0			6,0 - 8,0			221 331 48120
	14,0			7,5 - 10,0			221 331 48140
	16,0			9,5 - 12,0			221 331 48160
	18,0			11,5 - 14,0			221 331 48180
6,4	20,0	13,0	6,5 - 6,7	13,5 - 16,0	9 500	7 500	221 331 48200
	24,0			15,0 - 19,5			221 331 48240
	12,0			3,5 - 7,0			221 331 64120
	15,0			6,5 - 10,0			221 331 64150
	18,0			9,5 - 13,0			221 331 64180
6,4	22,0	13,0	6,5 - 6,7	12,5 - 17,0	9 500	7 500	221 331 64220
	26,0			16,5 - 21,0			221 331 64260
	30,0			20,5 - 25,0			221 331 64300



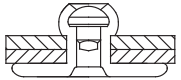
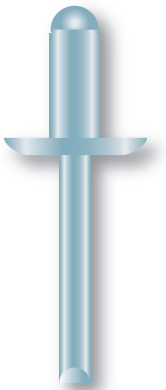

English	Français	Deutsch	Italiano	Español
Extra-large head	Tête extra-large	Extra großer Kopf	Testa extra-larga	Cabeza extra-grande
Stainless steel A2	Inox A2	Edelstahl A2	Inox A2	Inox A2
Stainless steel A2	Inox A2	Edelstahl A2	Inox A2	Inox A2

d1 (mm)	l (mm)	d2 (mm)	Ø (mm)	min - max (mm)	N	N	Cod.
4,8	10,0	16	4,9 - 5,0	4,0 - 6,0	5 800	4 700	221 336 48100
	12,0			5,5 - 8,0			221 336 48120
	14,0			7,5 - 10,0			221 336 48140
	16,0			9,5 - 12,0			221 336 48160
	20,0			13,5 - 16,5			221 336 48200

The references marked in blue are available from stock - Unless sold in the meantime.

Les articles avec code article en bleu sont tenus en stock - sauf vente entre-temps.

Die blau markierten Artikel sind ab Lager lieferbar - falls nicht zwischenzeitlich verkauft.

I riferimenti contrassegnati in blu sono disponibili a magazzino - Salvo venduto.

Las referencias marcadas en azul están disponibles en stock - salvo venta.



English	Français	Deutsch	Italiano	Español
Dome head	Tête plate	Flachrundkopf	Testa tonda	Cabeza alomada
Aluminium Al Mg 2,5	Aluminium Al Mg 2,5	Aluminium Al Mg 2,5	Alluminio Al Mg 2,5	Aluminio Al Mg 2,5
Aluminium Al Mg 5	Aluminium Al Mg 5	Aluminium Al Mg 5	Alluminio Al Mg 5	Aluminio Al Mg 5

3,2	6,0	6,5	3,3 - 3,4	1,0 - 3,0	850	600	221 371 32060
	8,0			3,0 - 5,0			221 371 32080
	10,0			5,0 - 7,0			221 371 32100
	12,0			7,0 - 9,0			221 371 32120
4,0	6,0	8,0	4,1 - 4,2	1,0 - 2,5	1 200	800	221 371 40060
	8,0			3,0 - 4,5			221 371 40080
	10,0			5,0 - 6,5			221 371 40100
	12,0			7,0 - 8,5			221 371 40120
	14,0			8,0 - 10,5			221 371 40140
	16,0			10,0 - 13,0			221 371 40160
20,0	13,5 - 16,0	221 371 40200					
4,8	8,0	9,5	4,9 - 5,0	2,5 - 4,0	2 100	1 700	221 371 48080
	10,0			4,5 - 6,0			221 371 48100
	12,0			6,5 - 8,0			221 371 48120
	14,0			7,5 - 10,0			221 371 48140
	16,0			9,5 - 12,0			221 371 48160
	18,0			11,5 - 14,0			221 371 48180
20,0	13,5 - 16,5	221 371 48200					





English	Français	Deutsch	Italiano	Español
Dome head	Tête plate	Flachrundkopf	Testa tonda	Cabeza alomada
Aluminium Al Mg 3,5	Aluminium Al Mg 3,5	Aluminium Al Mg 3,5	Alluminio Al Mg 3,5	Aluminio Al Mg 3,5
Stainless steel A2	Inox A2	Edelstahl A2	Inox A2	Inox A2

d1 (mm)	l (mm)	d2 (mm)	Ø (mm)	min - max (mm)	N	N	Cod.
3,0	6,0	6,5	3,1 - 3,2	1,0 - 3,0	950	600	221 351 30060
	8,0			3,0 - 5,0			221 351 30080
	10,0			5,0 - 7,0			221 351 30100
3,2	6,0	6,5	3,3 - 3,4	1,0 - 3,0	1 000	750	221 351 32060
	8,0			3,0 - 5,0			221 351 32080
	10,0			5,0 - 7,0			221 351 32100
	12,0			7,0 - 9,0			221 351 32120
4,0	6,0	8,0	4,1 - 4,2	1,0 - 2,5	1 750	1 200	221 351 40060
	8,0			3,0 - 4,5			221 351 40080
	10,0			5,0 - 6,5			221 351 40100
	12,0			7,0 - 8,5			221 351 40120
	14,0			8,0 - 10,5			221 351 40140
	16,0			10,0 - 12,5			221 351 40160
4,8	20,0	9,5	4,9 - 5,0	14,0 - 16,5	2 600	1 850	221 351 40200
	6,0			0,5 - 2,0			221 351 48060
	8,0			2,5 - 4,0			221 351 48080
	10,0			4,5 - 6,0			221 351 48100
	12,0			6,5 - 8,0			221 351 48120
	14,0			7,5 - 10,0			221 351 48140
	16,0			9,5 - 12,0			221 351 48160
	18,0			11,5 - 14,0			221 351 48180
	20,0			13,5 - 16,0			221 351 48200
26,0	19,5 - 22,0	221 351 48260					
30,0	23,5 - 26,0	221 351 48300					

The references marked in blue are available from stock - Unless sold in the meantime.

Les articles avec code article en bleu sont tenus en stock - sauf vente entre-temps.

Die blau markierten Artikel sind ab Lager lieferbar - falls nicht zwischenzeitlich verkauft.

I riferimenti contrassegnati in blu sono disponibili a magazzino - Salvo venduto.

Las referencias marcadas en azul están disponibles en stock - salvo venta.

RIVQUICK® – Peel type rivets - Rivets éclatés - Spreizblindniete - Rivetti a fiore - Remaches de flor

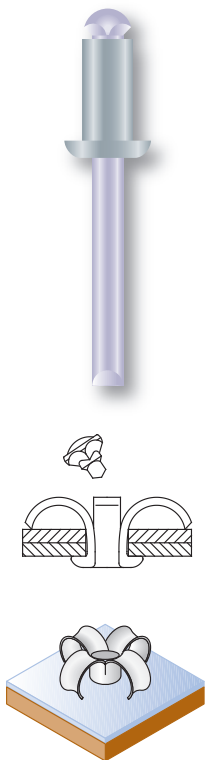

English	Français	Deutsch	Italiano	Español
Dome head	Tête plate	Flachrundkopf	Testa tonda	Cabeza alomada
Aluminium Al Mg 3,5	Aluminium Al Mg 3,5	Aluminium Al Mg 3,5	Alluminio Al Mg 3,5	Aluminio Al Mg 3,5
Steel zinc plated	Acier zingué	Stahl verzinkt	Acciaio zincato	Acero cincado

d1 (mm)	l (mm)	d2 (mm)	Ø (mm)	min - max (mm)	N	N	Cod.
4,0	12,0	8,0	4,2 - 4,3	3,0 - 6,0	1 500	1 250	221 413 40120
	16,0			5,5 - 10,0			221 413 40160
	20,0			9,5 - 14,0			221 413 40200
	24,0			13,5 - 18,0			221 413 40240
4,8	12,0	9,5	5,2 - 5,3	3,0 - 7,0	2 000	1 900	221 413 48120
	14,0			4,0 - 8,0			221 413 48140
	16,0			4,5 - 10,0			221 413 48160
	20,0			9,5 - 14,0			221 413 48200
	24,0			13,5 - 18,0			221 413 48240
	30,0			17,5 - 22,0			221 413 48300
	35,0			21,5 - 27,0			221 413 48350
	40,0			26,5 - 32,0			221 413 48400
	45,0			31,5 - 37,0			221 413 48450
	50,0			36,5 - 42,0			221 413 48500



RIVQUICK® – Slotted rivets - Rivets fendus - Presslaschenblindniete - Rivetti 3 ali - Remaches de trébol



English	Français	Deutsch	Italiano	Español
Dome head	Tête plate	Flachrundkopf	Testa tonda	Cabeza alomada
Aluminium Al Mg 2,5	Aluminium Al Mg 2,5	Aluminium Al Mg 2,5	Alluminio Al Mg 2,5	Aluminio Al Mg 2,5
Aluminium Al Mg 5	Aluminium Al Mg 5	Aluminium Al Mg 5	Alluminio Al Mg 5	Aluminio Al Mg 5

d1 (mm)	l (mm)	d2 (mm)	Ø (mm)	min - max (mm)	N	N	Cod.
4,0	16,0	8,0	4,2 - 4,4	1,0 - 5,0	800	700	221 478 40160
	20,0			3,0 - 8,0			221 478 40200
	25,0			5,0 - 11,0			221 478 40250
4,8	16,0	9,5	5,1 - 5,4	1,0 - 3,0	1 600	1 100	221 478 48160
	20,0			3,0 - 8,0			221 478 48200
	25,0			5,0 - 11,0			221 478 48250

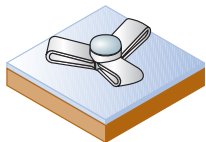
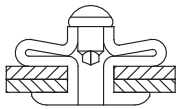

The references marked in blue are available from stock - Unless sold in the meantime.

Les articles avec code article en bleu sont tenus en stock - sauf vente entre-temps.

Die blau markierten Artikel sind ab Lager lieferbar - falls nicht zwischenzeitlich verkauft.

I riferimenti contrassegnati in blu sono disponibili a magazzino - Salvo venduto.

Las referencias marcadas en azul están disponibles en stock - salvo venta.

RIVQUICK® – Sealed type rivets - Rivets étanches - Becher-Dichtblindniete - Rivetti stagni - Remaches estancos

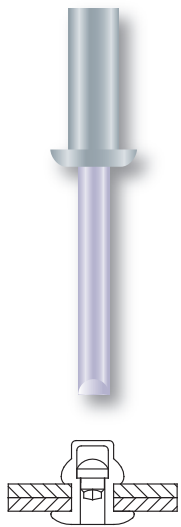

English	Français	Deutsch	Italiano	Español
Dome head	Tête plate	Flachrundkopf	Testa tonda	Cabeza alomada
Aluminium Al Mg 3,5	Aluminium Al Mg 3,5	Aluminium Al Mg 3,5	Alluminio Al Mg 3,5	Aluminio Al Mg 3,5
Polished steel	Acier poli	Stahl verzinkt	Acciaio zincato	Acero cincado

	d1 (mm)	l (mm)	d2 (mm)	Ø (mm)	min - max (mm)	N	N	Cod.
3,2	8,0	6,5	3,3 - 3,4		1,5 - 3,0	1150	900	221 411 32080
	9,5				3,0 - 5,5			221 411 32095
	10,7				4,5 - 6,0			221 411 32110
	11,5				6,0 - 7,5			221 411 32115
	12,7				7,0 - 9,0			221 411 32130
4,0	8,0	8,0	4,1 - 4,2		1,0 - 3,0	2 200	1 500	221 411 40080
	10,0				3,0 - 5,0			221 411 40100
	11,5				5,0 - 6,5			221 411 40115
	13,0				6,5 - 8,5			221 411 40130
	14,5				8,0 - 10,5			221 411 40145
4,8	9,5	9,5	4,9 - 5,0		3,0 - 5,0	2 750	2 200	221 411 48095
	11,0				5,0 - 7,0			221 411 48110
	12,5				6,0 - 8,0			221 411 48125
	15,5				8,5 - 11,0			221 411 48155
	18,0				10,5 - 13,0			221 411 48180
	22,0				13,0 - 16,0			221 411 48220

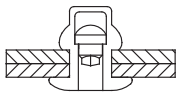

English	Français	Deutsch	Italiano	Español
Dome head	Tête plate	Flachrundkopf	Testa tonda	Cabeza alomada
Stainless steel A2	Inox A2	Edelstahl A2	Inox A2	Inox A2
Stainless steel A2	Inox A2	Edelstahl A2	Inox A2	Inox A2

d1 (mm)	l (mm)	d2 (mm)	Ø (mm)	min - max (mm)	N	N	Cod.
3,2	8,0	6,5	3,3 - 3,4	1,0 - 3,0	2 200	2 000	221 431 32080
	9,5			3,0 - 5,0			221 431 32095
	12			5,0 - 6,5			221 431 32120
4,0	8,0	8,0	4,1 - 4,2	1,0 - 3,0	3 400	3 300	221 431 40080
	9,5			3,0 - 5,0			221 431 40095
	12,0			5,0 - 6,5			221 431 40120
	16,0			6,5 - 10,5			221 431 40160
4,8	9,5	9,5	4,9 - 5,0	3,0 - 5,0	5 200	4 200	221 431 48095
	12,0			5,0 - 6,5			221 431 48120

The references marked in blue are available from stock - Unless sold in the meantime.

Les articles avec code article en bleu sont tenus en stock - sauf vente entre-temps.

Die blau markierten Artikel sind ab Lager lieferbar - falls nicht zwischenzeitlich verkauft.

I riferimenti contrassegnati in blu sono disponibili a magazzino - Salvo venduto.

Las referencias marcadas en azul están disponibles en stock - salvo venta.

RIVQUICK® Varigrip – Multigrip - Multiserrage - Mehrbereichsblindniete - Multigrip - Multigrip

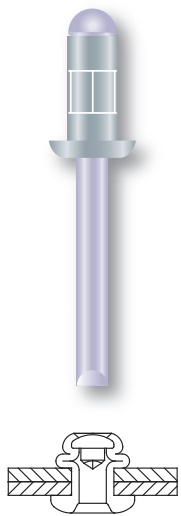

English	Français	Deutsch	Italiano	Español
Dome head	Tête plate	Flachrundkopf	Testa tonda	Cabeza alomada
Aluminium Al Mg 3,5	Aluminium Al Mg 3,5	Aluminium Al Mg 3,5	Alluminio Al Mg 3,5	Aluminio Al Mg 3,5
Steel zinc plated	Acier zingué	Stahl verzinkt	Acciaio zincato	Acero cincado

d1 (mm)	l (mm)	d2 (mm)	Ø (mm)	min - max (mm)	N	N	Cod.
3,2	8,0	6,5	3,3 - 3,4	1,0 - 5,5	900	650	221 211 32080
	9,5			3,0 - 6,5			221 211 32095
	11,5			4,5 - 8,0			221 211 32115
4,0	10,0	8,0	4,1 - 4,2	1,5 - 6,5	1 550	950	221 211 40100
	13,0			4,5 - 9,5			221 211 40130
	17,0			8,0 - 13,0			221 211 40170
4,8	11,0	9,5	5,0 - 5,2	1,0 - 6,5	2 200	1 700	221 211 48110
	15,0			5,0 - 10,5			221 211 48150
	17,0			6,0 - 12,5			221 211 48170
	25,0			12,5 - 20,0			221 211 48250

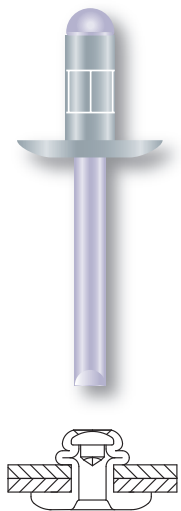

English	Français	Deutsch	Italiano	Español
Extra-large head	Tête extra-large	Extra großer Kopf	Testa extra-larga	Cabeza extra-grande
Aluminium Al Mg 3,5	Aluminium Al Mg 3,5	Aluminium Al Mg 3,5	Alluminio Al Mg 3,5	Aluminio Al Mg 3,5
Steel zinc plated	Acier zingué	Stahl verzinkt	Acciaio zincato	Acero cincado

d1 (mm)	l (mm)	d2 (mm)	Ø (mm)	min - max (mm)	N	N	Cod.
4,8	10,0	16,0	5,0 - 5,2	1,0 - 6,0	2 200	1 700	221 216 48100
	16,0			6,0 - 12,0			221 216 48160
	25,0			13,0 - 20,0			221 216 48250

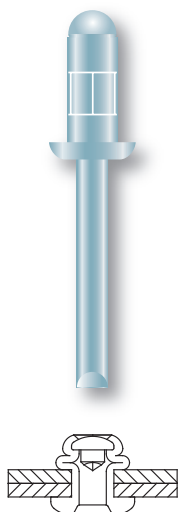

English	Français	Deutsch	Italiano	Español
Dome head	Tête plate	Flachrundkopf	Testa tonda	Cabeza alomada
Stainless steel A2	Inox A2	Edelstahl A2	Inox A2	Inox A2
Stainless steel A2	Inox A2	Edelstahl A2	Inox A2	Inox A2

d1 (mm)	l (mm)	d2 (mm)	Ø (mm)	min - max (mm)	N	N	Cod.
3,2	12,0	6,5	3,3 - 3,4	1,0 - 7,0	2 200	1 700	220 231 32120
4,0	13,0	8,0	4,1 - 4,2	2,0 - 8,0	3 400	3 800	220 231 40130
4,8	14,0	9,5	4,9 - 5,0	1,5 - 9,0	5 000	4 500	220 231 48140

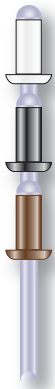

English	Français	Deutsch	Italiano	Español
Dome head	Tête plate	Flachrundkopf	Testa tonda	Cabeza alomada
Aluminium Al Mg 3,5	Aluminium Al Mg 3,5	Aluminium Al Mg 3,5	Alluminio Al Mg 3,5	Aluminio Al Mg 3,5
Steel zinc plated	Acier zingué	Stahl verzinkt	Acciaio zincato	Acero cincado

d1 (mm)	l (mm)	d2 (mm)	Ø (mm)	min - max (mm)	N	N	RAL	Cod.		
								9010	9005	8017
3,0	6,0	6,5	3,1 - 3,2	1,0 - 3,0	950	600	221 611	30064	30063	30062
	8,0			221 611			30084	30083	30082	
	10,0			221 611			30104	30103	30102	
	12,0			221 611			30124	30123	30122	
3,2	6,0	6,5	3,3 - 3,4	1,0 - 3,0	1 000	750	221 611	32064	32063	32062
	7,0			221 611			32084	32083	32082	
	8,0			221 611			32104	32103	32102	
	9,0			221 611			32124	32123	32122	
4,0	7,0	8,0	4,1 - 4,2	2,0 - 3,5	1 750	1 200	221 611	40074	40073	40072
	8,0			221 611			40084	40083	40082	
	9,0			221 611			40094	40093	40092	
	10,0			221 611			40104	40103	40102	
	11,0			221 611			40114	40113	40112	
	12,0			221 611			40124	40123	40122	
	14,0			221 611			40144	40143	40142	
	16,0			221 611			40164	40163	40162	
4,8	7,0	9,5	4,9 - 5,0	1,5 - 3,0	2 600	1 850	221 611	48074	48073	48072
	8,0			221 611			48084	48083	48082	
	9,0			221 611			48094	48093	48092	
	10,0			221 611			48104	48103	48102	
	11,0			221 611			48114	48113	48112	
	12,0			221 611			48124	48123	48122	
	14,0			221 611			48144	48143	48142	
16,0	221 611	48164	48163	48162						

The references marked in blue are available from stock - Unless sold in the meantime.
 Les articles avec code article en bleu sont tenus en stock - sauf vente entre-temps.
 Die blau markierten Artikel sind ab Lager lieferbar - falls nicht zwischenzeitlich verkauft.
 I riferimenti contrassegnati in blu sono disponibili a magazzino - Salvo venduto.
 Las referencias marcadas en azul están disponibles en stock - salvo venta.



English	Français	Deutsch	Italiano	Español
Dome head	Tête plate	Flachrundkopf	Testa tonda	Cabeza alomada
Aluminium Al Mg 3,5	Aluminium Al Mg 3,5	Aluminium Al Mg 3,5	Alluminio Al Mg 3,5	Aluminio Al Mg 3,5
Steel zinc plated	Acier zingué	Stahl verzinkt	Acciaio zincato	Acero cincado

d1 (mm)	l (mm)	d2 (mm)	Ø (mm)	min - max (mm)	N	N	RAL	Cod.	
								9010	9005
4,0	16,0	8,0	4,4 - 4,5	8,0 - 11,0	900	1 000	220 413	40001	40002

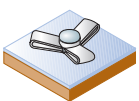

English	Français	Deutsch	Italiano	Español
Dome head	Tête plate	Flachrundkopf	Testa tonda	Cabeza alomada
Aluminium Al Mg 3,5	Aluminium Al Mg 3,5	Aluminium Al Mg 3,5	Alluminio Al Mg 3,5	Aluminio Al Mg 3,5
Aluminium Al Mg 5	Aluminium Al Mg 5	Aluminium Al Mg 5	Alluminio Al Mg 5	Aluminio Al Mg 5

d1 (mm)	l (mm)	d2 (mm)	Ø (mm)	min - max (mm)	N	N	RAL	Cod.		
								9002	9005	5017
4,0	20,0	8,0	4,3 - 4,5	1,0 - 7,0	1 000	600	220 478	40001	40002	40003

- 🇬🇧 We can provide rivets with standard RAL or custom colours. For prices and minimum quantity: contact us.
- 🇫🇷 Les rivets peuvent être livrés dans toutes les couleurs RAL ou sur échantillon. Prix et quantité minimum : nous consulter.
- 🇩🇪 Blindniete sind in vielen RAL-Farben erhältlich. Preise und Mindestbestellmengen auf Anfrage.
- 🇮🇹 Forniamo rivetti in tutte le colorazioni RAL o su campione. Per prezzi e quantità minime contattateci.
- 🇪🇸 Los remaches pueden suministrarse en todos los colores RAL o muestras. Para precios y cantidades mínimas, consúltenos.

RIVQUICK® – Stainless steel A4 - Inox A4 - Edelstahl A4 - Inox A4 - Inox A4

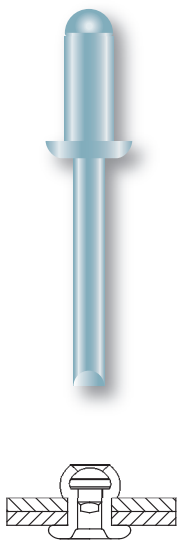

English	Français	Deutsch	Italiano	Español
Dome head	Tête plate	Flachrundkopf	Testa tonda	Cabeza alomada
Stainless steel A4	Inox A4	Edelstahl A4	Inox A4	Inox A4
Stainless steel A4	Inox A4	Edelstahl A4	Inox A4	Inox A4

d1 (mm)	l (mm)	d2 (mm)	Ø (mm)	min - max (mm)	N	N	Cod.
3,2	6,0	6,5	3,3 - 3,4	0,5 - 3,0	2 600	2 200	221 381 32060
	8,0			3,0 - 5,0			221 381 32080
	10,0			4,0 - 6,0			221 381 32100
4,0	8,0	8,0	4,1 - 4,2	2,0 - 4,5	4 100	3 300	221 381 40080
	10,0			4,0 - 6,5			221 381 40100
	12,0			6,5 - 8,0			221 381 40120
	14,0			7,0 - 9,5			221 381 40140
4,8	8,0	9,5	4,9 - 5,0	2,5 - 4,0	6 000	4 800	221 381 48080
	10,0			4,0 - 6,0			221 381 48100
	12,0			6,0 - 8,0			221 381 48120
	14,0			7,5 - 10,0			221 381 48140

RIVQUICK® – Earthing rivets - Rivets masse - Erdungsblindniete - Rivetti di messa a terra - Remaches de toma de tierra

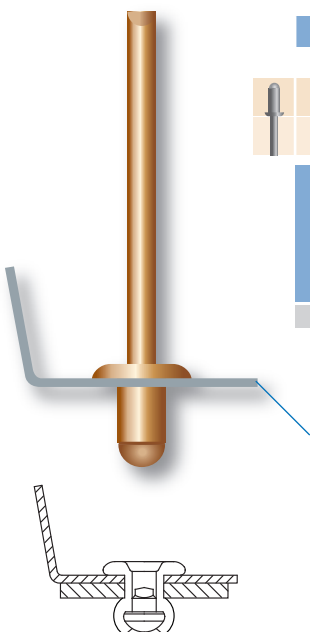

English	Français	Deutsch	Italiano	Español
Dome head	Tête plate	Flachrundkopf	Testa tonda	Cabeza alomada
Copper	Cuivre	Kupfer	Rame	Cobre
Steel copper plated	Acier cuivré	Stahl verkupfert	Acciaio Rame	Cobre acero

d1 (mm)	l (mm)	d2 (mm)	Ø (mm)	min - max (mm)	N	N	Cod.			
4,0	6,0	-	5,3 - 5,4	0,8 - 1,5	1 700	1 200	221 949 4000X	8	3	4









Brass / Laiton / Messing / Ottone / Latón

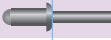
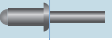

- 🇬🇧 Our R&D department, located in our plant in Chambéry (France), develops solutions engineered to your application.
- 🇫🇷 Notre bureau d'étude, situé dans notre usine de Chambéry, conçoit et développe des solutions spécifiques adaptées à votre cahier des charges.
- 🇩🇪 Unsere Entwicklungsabteilung am Produktionsstandort in Chambéry (Frankreich) erarbeitet individuelle Produktlösungen für Ihre Anwendungen.
- 🇮🇹 I nostri uffici Ricerca e Sviluppo situati a Chambéry (Francia) sviluppano soluzioni specifiche per le vostre richieste.
- 🇪🇸 Nuestro departamento de I+D, situado en nuestras fábricas de Chambéry (Francia), desarrolla soluciones adaptadas a sus necesidades específicas.



RIVQUICK® – High strength and structural rivets - Rivets haute résistance et de structure - Hochfeste Blindniete - Rivetti ad alta resistenza e strutturali - Remaches de alta resistencia y estructurales

	Material - Matière - Materialien - Materiale - Material						Head - Tête - Kopf - Testa - Cabeza	
								
	steel	steel	stainless steel	stainless steel	alu	alu	dome	countersunk
	acier	acier	inox	inox	alu	alu	plate	fraisée
	Stahl	Stahl	Edelstahl	Edelstahl	Aluminium	Aluminium	Flachrundkopf	Senkkopf
	acciaio	acciaio	inox	inox	allu	allu	tonda	svasata
	acero	acero	inox	inox	alu	alu	alomada	fresada

RIVQUICK® Varibulb





High strength - Haute résistance - Hochfeste Blindniete - Alta resistenza - Alta resistencia



	•			•		29
		•		•		29

RIVQUICK® Varibolt

Structural - Structure - Hochfeste Blindniete - Strutturali - Estructurales

	•			•		31
	•				•	31
			•	•		31
		•			•	32
		•				32

RIVQUICK® Varilock

Structural - Structure - Hochfeste Blindniete - Strutturali - Estructurales

	•			•		34
--	---	--	--	---	--	----



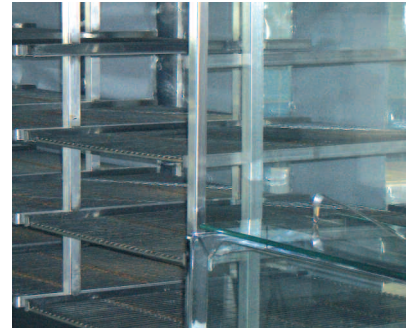
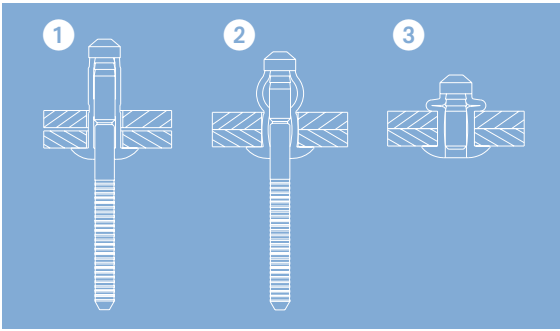

- ✚ These rivets optimize security and vibration resistance of the assembly.
The pre-determined mandrel breakage point and retention within the rivet body provides very high shear resistance.
The specific deformation, obtained at the moment of riveting, and the distribution of the joining forces, allow riveting of thin sheet materials
- 🇮🇹 Ces rivets garantissent des assemblages sûrs et insensibles aux vibrations.
La rupture décalée et le verrouillage des tiges assurent une résistance élevée au cisaillement.
La déformation spécifique obtenue lors du sertissage et la répartition des forces d'accostage qui en résulte permettent la pose sur des pièces de faibles épaisseurs.
- 🇩🇪 Diese Blindniete gewährleisten eine feste und vibrations sichere Montage.
Durch die Sollbruchstelle des Dorns und den Halt im Nietkörper ist die Scherfestigkeit überdurchschnittlich hoch.
Die spezifische Verformung, die im Moment der Vernietung entsteht, sowie die Verteilung der Fügekräfte ermöglichen das Vernieten von Dünnschichten.
- 🇮🇹 Questa tipologia di rivetti garantisce un assemblaggio sicuro e resistente alle vibrazioni.
La rottura predeterminata e il bloccaggio dei chiodi assicura resistenza al taglio superiore allo standard.
La deformazione specifica ottenuta al momento del serraggio e la ripartizione delle forze di accostamento permettono la posa su materiali di spessori sottili.
- 🇪🇸 Estos remaches garantizan uniones seguras y resistentes a las vibraciones.
La envoltura de la cabeza de los vástagos después de la colocación asegura una gran resistencia al cizallamiento.
La deformación específica obtenida en la colocación y la repartición de las fuerzas de la unión hacen posible su colocación en piezas de poco espesor.

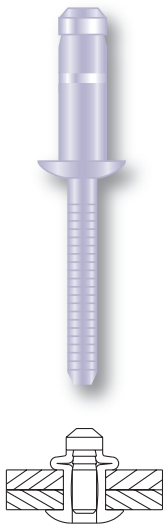

English	Français	Deutsch	Italiano	Español
Dome head	Tête plate	Flachrundkopf	Testa tonda	Cabeza alomada
Steel zinc plated	Acier zingué	Stahl verzinkt	Acciaio zincato	Acero cincado
Steel zinc plated	Acier zingué	Stahl verzinkt	Acciaio zincato	Acero cincado

	d1 (mm)	l (mm)	d2 (mm)	Ø (mm)	min - max (mm)	N	N	Cod.
3,2	11,0	6,5	3,3 - 3,4		1,0 - 3,0	1 250	2 400	221 823 32070
	13,0				3,0 - 5,0			221 823 32090
	15,0				5,0 - 7,0			221 823 32110
4,0	11,0	8,0	4,1 - 4,2		1,0 - 3,0	2 100	3 400	221 823 40070
	13,0				3,0 - 5,0			221 823 40090
	16,0				5,0 - 7,0			221 823 40120
4,8	12,1	9,3	5,0 - 5,2		1,5 - 3,5	3 800	3 300 - 3 600	223 821 48121
	14,6				3,5 - 5,5		3 300 - 4 200	223 821 48146
	17,0				2,0 - 6,0		5 000 - 10 000	223 823 64170
6,4	20,0	12,7	6,6 - 7,0		5,0 - 9,0	7 000		223 823 64200

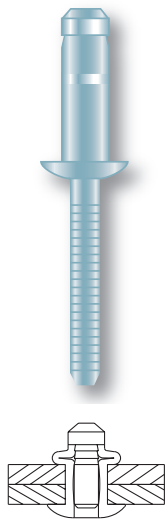

English	Français	Deutsch	Italiano	Español
Dome head	Tête plate	Flachrundkopf	Testa tonda	Cabeza alomada
Stainless steel A2	Inox A2	Edelstahl A2	Inox A2	Inox A2
Stainless steel A2	Inox A2	Edelstahl A2	Inox A2	Inox A2

	d1 (mm)	l (mm)	d2 (mm)	Ø (mm)	min - max (mm)	N	N	Cod.
3,2	11,0	6,5	3,3 - 3,4		1,0 - 3,0	2 650	3 700	221 833 32070
	13,0				2,0 - 4,5			221 833 32090
	15,0				4,5 - 7,0			221 833 32110
4,0	11,0	8,0	4,1 - 4,2		1,0 - 3,0	3 900	5 500	221 833 40070
	13,0				2,0 - 4,0			221 833 40090
	16,0				4,0 - 7,0			221 833 40120
4,8	12,9	9,3	5,0 - 5,2		1,5 - 3,5	5 300	3 900 - 5 000	223 831 48129
	14,6				3,5 - 5,5		223 831 48155	
	17,6				5,5 - 7,5		223 831 48180	
6,4	17,0	12,7	6,6 - 7,0		2,0 - 6,0	8 500	7 500 - 15 000	223 833 64170
	20,0				5,0 - 9,0		223 833 64200	

The references marked in blue are available from stock - Unless sold in the meantime.

Les articles avec code article en bleu sont tenus en stock - sauf vente entre-temps.

Die blau markierten Artikel sind ab Lager lieferbar - falls nicht zwischenzeitlich verkauft.

I riferimenti contrassegnati in blu sono disponibili a magazzino - Salvo vendita.

Las referencias marcadas en azul están disponibles en stock - salvo venta.

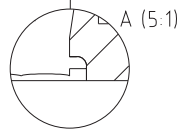
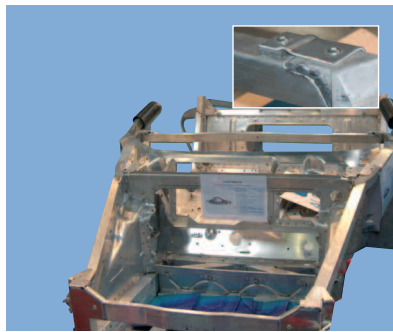
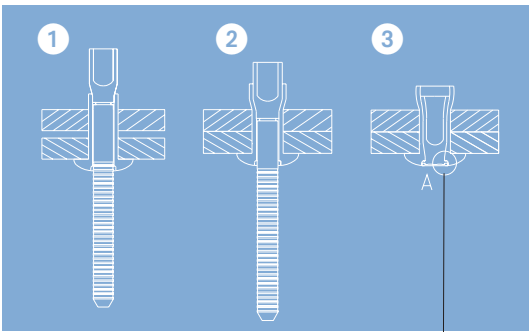

Visual check that stem has been locked during setting (see specific nosepiece on page 39/41)
 Verrouillage de la tige visible après pose (voir embouchure à utiliser page 39/41)
 Sichtkontrolle der Nietnagelverriegelung während des Setzvorgangs (siehe spezielles Mundstück auf Seite 39/41)
 Bloccaggio meccanico del chiodo visibile dopo la posa (vedere nasello da utilizzare a pag 39/41)
 Vista del cierre del vástago después de la colocación (ver boquilla de colocación a utilizar, en la pág. 39/41)

- ✚ The wide grip range of these rivets allows fastener rationalisation and with consequent inventory reduction. The shear resistance values obtained with these rivets are very high, giving greater rigidity to the assembled structures. The clenching action of the rivet allows metal plates to be joined, even where there are significant gaps, along with the possibility of use in laminates of variable thickness.
- 🇫🇷 La large plage de sertissage de ces rivets permet une réduction des stocks de composants et une utilisation sur des épaisseurs variables. La puissance de l'accostage permet le contact des supports même lors d'espacements importants. L'effort d'accostage est maintenu dans l'assemblage et résiste aux déformations et vibrations des applications. Le système de mandrin à tête creuse garantit le bon remplissage des trous et de l'étanchéité aux eaux de ruissellement.
- 🇩🇪 Der große Klemmbereich dieser Nieten ermöglicht eine Rationalisierung der Verbindungselemente und somit auch eine Reduzierung der Lagerbestände. Die Scherfestigkeit, die mit diesen Nieten erreicht wird, ist sehr hoch, so dass die montierten Komponenten eine höhere Festigkeit aufweisen. Aufgrund der Klemmkraft des Niets können Bleche auch bei beträchtlichen Spaltgrößen gefügt werden. Der Niet kann außerdem zum Fügen von Bauteilen unterschiedlicher Dicke verwendet werden.
- 🇮🇹 L'ampia gamma di serraggio di questi rivetti permette una riduzione dello stock dei componenti con la possibilità di impiego su superfici di spessore variabile. I valori al taglio ottenuti con questi rivetti sono notevolmente superiori alla media, determinando un'elevata rigidità delle strutture assemblate. L'azione del rivetto permette l'accostamento delle lamiere anche in caso di scostamenti delle parti da unire.
- 🇪🇸 Su gran zona de ramachado le permite absorber variaciones de espesores y posibilita la reducción del número de referencias en el almacén. Esta característica del remache permite grandes tolerancias de fabricación en la piezas a montar sin reducir las características de la fijación. La fuerza de colocación se mantiene en la unión, lo que asegura una perfecta resistencia a las deformaciones y vibraciones de las aplicaciones. El sistema de vástago con cabeza hueca garantiza el relleno total del alojamiento y la estanqueidad al agua o las salpicaduras.

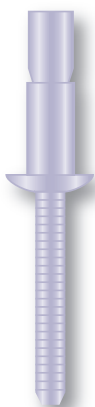

English	Français	Deutsch	Italiano	Español
Dome head	Tête plate	Flachrundkopf	Testa tonda	Cabeza alomada
Steel zinc plated	Acier zingué	Stahl verzinkt	Acciaio zincato	Acero cincado
Steel zinc plated	Acier zingué	Stahl verzinkt	Acciaio zincato	Acero cincado

d1 (mm)	l (mm)	d2 (mm)	Ø (mm)	min - max (mm)	N	N	Cod.
4,8	20,0	9,5	4,9 - 5,1	1,6 - 6,8	5 000	5 900	223 821 48100
	25,0			1,6 - 11,1			223 821 48140
6,4	24,0	13,2	6,6 - 7,0	2,0 - 9,5	9 500	11 100	223 821 64140
	33,0			2,0 - 15,9			223 821 64190

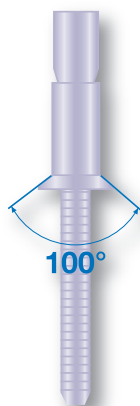
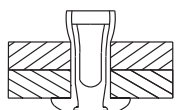

English	Français	Deutsch	Italiano	Español
Countersunk head	Tête fraisée	Senkkopf	Testa svasata	Cabeza fresada
Steel zinc plated	Acier zingué	Stahl verzinkt	Acciaio zincato	Acero cincado
Steel zinc plated	Acier zingué	Stahl verzinkt	Acciaio zincato	Acero cincado

d1 (mm)	l (mm)	d2 (mm)	Ø (mm)	min - max (mm)	N	N	Cod.
4,8	21,0	8,5	4,8 - 5,2	3,2 - 8,4	5 000	5 900	223 822 48130
				3,2 - 12,1			223 822 64160
6,4	27,0	10,1	6,6 - 7,0		7 400	10 500	



Nose piece
Embouchure
Sondermundstück
Nasello
Boquilla



Ø 4,8 Varibolt
Ø 6,4 Varibolt

RIVQUICK® P1000	RIVQUICK® P2000	RIVQUICK® P3000
226 031 48001		226 041 48002
	226 032 64001	226 041 64003

The references marked in blue are available from stock - Unless sold in the meantime.

Les articles avec code article en bleu sont tenus en stock - sauf vente entre-temps.

Die blau markierten Artikel sind ab Lager lieferbar - falls nicht zwischenzeitlich verkauft.

I riferimenti contrassegnati in blu sono disponibili a magazzino - Salvo vendita.

Las referencias marcadas en azul están disponibles en stock - salvo venta.



English	Français	Deutsch	Italiano	Español
Dome head	Tête plate	Flachrundkopf	Testa tonda	Cabeza alomada
Stainless steel A2	Inox A2	Edelstahl A2	Inox A2	Inox A2
Stainless steel A2	Inox A2	Edelstahl A2	Inox A2	Inox A2

d1 (mm)	l (mm)	d2 (mm)	Ø (mm)	min - max (mm)	N	N	Cod.
4,8	20,0	9,5	4,9 - 5,1	1,6 - 6,8	4 800	6 300	223 831 48100
	25,0			1,6 - 11,1			223 831 48140
6,4	24,0	13,2	6,6 - 7,0	2,0 - 9,5	9 500	11 100	223 831 64140
	33,0			2,0 - 15,9			223 831 64190

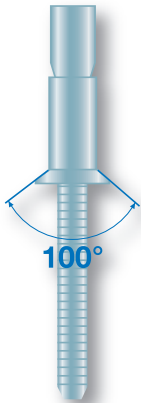
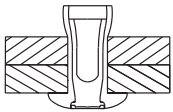

English	Français	Deutsch	Italiano	Español
Countersunk head	Tête fraisée	Senkkopf	Testa svasata	Cabeza fresada
Stainless steel A2	Inox A2	Edelstahl A2	Inox A2	Inox A2
Stainless steel A2	Inox A2	Edelstahl A2	Inox A2	Inox A2

d1 (mm)	l (mm)	d2 (mm)	Ø (mm)	min - max (mm)	N	N	Cod.
6,4	27,0	10,0	6,6 - 7,0	3,2 - 12,1	9 500	11 100	223 832 64160



Nose piece
Embouchure
Sondermundstück
Nasello
Boquilla



Ø 4,8 Varibolt

Ø 6,4 Varibolt

RIVQUICK® P1000	RIVQUICK® P2000	RIVQUICK® P3000
226 031 48001		226 041 48002
	226 032 64001	226 041 64003

The references marked in blue are available from stock - Unless sold in the meantime.

Les articles avec code article en bleu sont tenus en stock - sauf vente entre-temps.

Die blau markierten Artikel sind ab Lager lieferbar - falls nicht zwischenzeitlich verkauft.

I riferimenti contrassegnati in blu sono disponibili a magazzino - Salvo venduto.

Las referencias marcadas en azul están disponibles en stock - salvo venta.

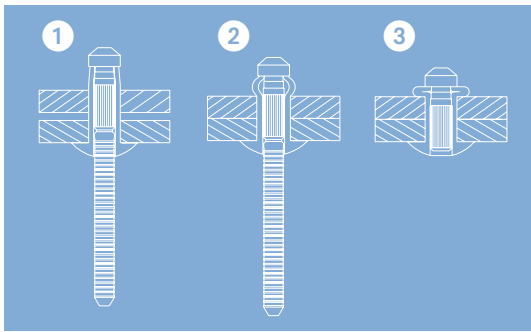
RIVQUICK® Varilock – Structural - Structure - Hochfeste Blindniete - Strutturali - Estructurales

- ✚ This range of rivet offers superior shear strength.
The convex surface area distributes the setting load over a wider area, to eliminate the possibility of surface damage to thin or soft materials.
- 🇫🇷 Ces rivets de structure sont indiqués pour des applications très fortement sollicitées, notamment à l'arrachement. La surface du bourrelet répartit les forces d'accostage sur une plus grande surface et permet la pose sans dommage sur des pièces de faibles épaisseurs ou sur des matériaux tendres.
- 🇩🇪 Diese Blindniete haben eine hohe Scherfestigkeit. Die konvexe Oberfläche leitet die Setzkräfte in eine vergrößerte Fläche ab, so dass die Oberfläche von dünnen oder weichen Materialien nicht beschädigt wird.
- 🇮🇹 Questa gamma di rivetti strutturali presenta una elevata resistenza allo strappo. La superfici della bombatura ripartisce le forze di accostamento su una più grande superficie e permette la posa senza danneggiamento in caso di spessori deboli o di materiali dolci.
- 🇪🇸 Esta gama de remaches estructurales se utiliza en aplicaciones que requieren una gran resistencia al arrancamiento. La deformación del remache producido por la acción del aparato de colocación reparte las fuerzas de unión sobre una superficie más grande y garantiza una perfecta colocación en piezas de poco espesor o en materiales blandos.



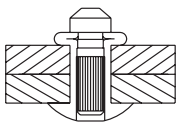
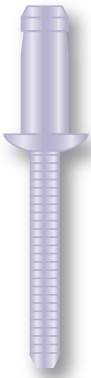

English	Français	Deutsch	Italiano	Español
Dome head	Tête plate	Flachrundkopf	Testa tonda	Cabeza alomada
Steel zinc plated	Acier zingué	Stahl verzinkt	Acciaio zincato	Acero cincado
Steel zinc plated	Acier zingué	Stahl verzinkt	Acciaio zincato	Acero cincado

d1 (mm)	l (mm)	d2 (mm)	Ø (mm)	min - max (mm)	N	N	Cod.
6,4	15,1	13,4	6,7 - 6,9	2,8 - 4,8	8 800	12 000	223 824 64150
	15,6			3,4 - 5,3		12 500	223 824 64156
	17,0			4,8 - 6,8		12 500	223 824 64170
	19,0			6,8 - 8,8		14 000	223 824 64190
	21,0			8,8 - 10,8		16 000	223 824 64210
	23,0			10,8 - 12,8		16 000	223 824 64230

The references marked in blue are available from stock - Unless sold in the meantime.

Les articles avec code article en bleu sont tenus en stock - sauf vente entre-temps.

Die blau markierten Artikel sind ab Lager lieferbar - falls nicht zwischenzeitlich verkauft.

I riferimenti contrassegnati in blu sono disponibili a magazzino - Salvo venduto.

Las referencias marcadas en azul están disponibles en stock - salvo venta.

RIVQUICK® – Riveting hand tools - Appareils de pose manuels - Blindnietwerkzeuge - Attrezzatura di posa - Equipos de colocación



- 🇬🇧 Hand-operated setting tools
- 🇫🇷 Outils de pose manuels
- 🇩🇪 Hand-Blindnietwerkzeuge
- 🇮🇹 Apparecchi di posa manuale
- 🇪🇸 Aparatos de colocación manuales

36



- 🇬🇧 Hydraulic/pneumatic blind riveting tool
- 🇫🇷 Appareils de pose oléopneumatiques
- 🇩🇪 Pneumatisch-hydraulische Blindnietwerkzeuge
- 🇮🇹 Apparecchi di posa oleopneumatica
- 🇪🇸 Aparatos de colocación oleoneumáticos

37



- 🇬🇧 Battery operated setting tools
- 🇫🇷 Outils de pose à batterie
- 🇩🇪 Akku-Blindnietwerkzeuge
- 🇮🇹 Apparecchi di posa a batteria
- 🇪🇸 Remachadoras a batería



40



RIVQUICK® – Hand-operated setting tools - Outils de pose manuels - Hand-Blindnietwerkzeuge - Apparecchi di posa manuale - Aparatos de colocación manuales

RIVQUICK® BRS 02 - Plier type setting tool - Pince à main - Hand-Blindnietwerkzeug - Pinza manuale - Pinza de mano

	Ø							
	2,4	3,0	3,2	4,0	4,8	5,0	6,0	6,4
Alu - Alu - Alu - Allu - Alu	■	■	■	■	■	■		
Zinc plated - Acier zingué - Stahl verzinkt Acciaio zincato - Acero cincado	■	■	■	■	■	■		
Stainless steel - Inox - Edelstahl - Inox - Inox	■	■	■					



 540 g  **225 020 00000**



Kits available - Existe en coffret - Im Koffer erhältlich - Disponibile anche con valigetta - Disponible también en cofre

RIVQUICK® BRS 10 - Lever type setting tool - Pince à levier - Hand-Blindnietwerkzeug - Pinza a leva - Pinza de palanca



	Ø							
	2,4	3,0	3,2	4,0	4,8	5,0	6,0	6,4
Alu - Alu - Alu - Allu - Alu		■	■	■	■	■	■	■
Zinc plated - Acier zingué - Stahl verzinkt Acciaio zincato - Acero cincado		■	■	■	■	■	■	■
Stainless steel - Inox - Edelstahl - Inox - Inox		■	■	■	■	■	■	

 1900 g  **225 210 00000**







RIVQUICK® BRS 20 - Extension type setting tool - Pince à extenseur - Hand-Blindnietwerkzeug - Pinza a estensione - Pinza extensora

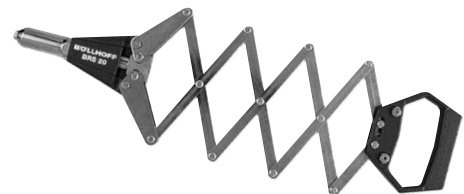



	Ø							
	2,4	3,0	3,2	4,0	4,8	5,0	6,0	6,4
Alu - Alu - Alu - Allu - Alu	■	■	■	■	■	■	■	■
Zinc plated - Acier zingué - Stahl verzinkt Acciaio zincato - Acero cincado	■	■	■	■	■	■	■	■
Stainless steel - Inox - Edelstahl - Inox - Inox	■	■	■	■	■	■	■	

 2000 g  **225 220 00000**



Riveting Kit BRS 02 - Coffret BRS 02 - Sortimentkoffer BRS 02 - Valigetta BRS 02 - Cofre BRS 02

-  BRS 02 plier tool and a selection of aluminium rivets with steel mandrel.
-  Avec une pince à main BRS 02 et un assortiment de rivets alu, tige acier, tête plate et tête large.
-  Hand-Blindnietwerkzeug RIVQUICK® BRS 02 und eine Auswahl an Blindnieten aus Aluminium mit Stahldorn.
-  Pinza con selezione di rivetti in alluminio con chiodo in acciaio.
-  Con una pinza de mano BRS 02 y un surtido de remaches de aluminio, vástago de acero, cabeza alomada y cabeza grande.



V	d1 (mm)	l (mm)	Head - Tête - Kopf - Testa - Cabeza	
				
	3,0	6	■	
	3,0	8	■	
	4,0	8	■	
	4,0	10	■	
	4,0	12	■	
	4,0	10		■
			+	
			1 x Ø 3,1 mm	
			1 x Ø 4,1 mm	



 **225 020 00501**

RIVQUICK® – Hydraulic/pneumatic blind riveting tool - Appareils de pose oléopneumatiques - Pneumatisch-hydraulische Blindnietwerkzeuge - Apparecchi di posa oleopneumatica - Aparatos de colocación oleoneumáticos

RIVQUICK® P series

	RIVQUICK® P1000	RIVQUICK® P2000	RIVQUICK® P3000
 Kg	1 250 g	1 650 g	1800 g
Setting force - Traction - Setzkraft Trazione - Tracción	7 300 N	12 500 N	16 000 N
Tool stroke - Course - Gerätehub Corsa - Recorrido	17 mm	21 mm	25 mm
 bars	5 - 7 bars	5 - 7 bars	5 - 7 bars

- 1/4 turn removable stem collector - Bol récupérateur de tiges démontable 1/4 de tour - Abnehmbarer Nietdorn-Auffangbehälter - Serbatoio recupera chiodi a sgancio rapido - Con recuperador de vástagos
- Vacuum stem collection - Aspiration des tiges - Mit Nietdorn-Absaugung- Aspirazione sottovuoto chiodi - Con aspiración de vástagos

RIVQUICK® P1000

	Ø									
	2,4*	3,0*	3,2*	4,0	4,8	4,8V	5,0	6,0	6,4	6,4V
Alu - Alu - Alu - Allu - Alu	■	■	■	■	■					
Zinc plated - Acier zingué - Stahl verzinkt Acciaio zincato - Acero cincado	■	■	■	■	■					
Stainless steel - Inox - Edelstahl - Inox - Inox	■	■	■	■	■					

 **226 030 01000**



- 🇬🇧 *Conversion kit 226 030 00086 is necessary for nose piece Ø 2.4 and nose piece Ø 3.2 (for stem diameter < 2.0mm)
- 🇫🇷 *Le kit de conversion 226 030 00086 est nécessaire pour l'utilisation d'embouchures Ø 2,4 et Ø 3,2 (pour les diamètres de tige < 2,0mm)
- 🇩🇪 *Umrüstsatz 226 030 00086 ist für die Verwendung von Mundstücken Ø 2,4 und Ø 3,2 notwendig (Nietdorndurchmesser < 2,0 mm)
- 🇮🇹 *Kit di conversione 226 030 00086 necessario per nasello Ø 2,4 e nasello Ø 3,2 (per diametro dello stelo < 2,0mm)
- 🇪🇸 *El kit de conversión 226 030 00086 es necesario para la utilización de las boquillas de Ø 2,4 y de Ø 3,2 (Para vástago de diámetro < 2,0mm)

RIVQUICK® P2000

	Ø									
	2,4*	3,0*	3,2*	4,0	4,8	4,8V	5,0	6,0	6,4	6,4V
Alu - Alu - Alu - Allu - Alu				■	■	■	■	■	■	
Zinc plated - Acier zingué - Stahl verzinkt Acciaio zincato - Acero cincado				■	■	■	■	■	■	
Stainless steel - Inox - Edelstahl - Inox - Inox				■	■	■	■	■	■	

 **226 031 01000**



- 🇬🇧 Recommended for RIVQUICK® Varibulb and RIVQUICK® Varibolt Ø 4.8 mm.
To set RIVQUICK® Varibolt, a specific nosepiece is recommended (see tools part of the catalogue).
- 🇫🇷 Recommandé pour les gammes RIVQUICK® Varibulb et RIVQUICK® Varibolt Ø 4,8 mm.
Pour la pose de rivets RIVQUICK® Varibolt, veuillez utiliser un nez spécifique à verrouillage (voir section pièces détachées - outillage).
- 🇩🇪 Empfohlen für RIVQUICK® Varibulb und RIVQUICK® Varibolt Ø 4,8 mm.
Zum Einbau von RIVQUICK® Varibolt Sondermundstück verwenden (siehe Ersatzteilübersicht).
- 🇮🇹 Consigliato per RIVQUICK® Varibulb e RIVQUICK® Varibolt Ø 4,8 mm.
Per la posa dei rivetti RIVQUICK® Varibolt, utilizzate un nasello speciale (vedere parte pezzi di ricambio/utensil).
- 🇪🇸 Recomendada para las gamas RIVQUICK® Varibulb y RIVQUICK® Varibolt Ø 4,8 mm.
Para la colocación de los remaches RIVQUICK® Varibolt, utilizar las boquillas especiales (ver la información sobre útiles y recambios contenida en este catálogo).





RIVQUICK® – Hydraulic/pneumatic blind riveting tool - Appareils de pose oléopneumatiques - Pneumatisch-hydraulische Blindnietwerkzeuge - Apparecchi di posa oleopneumatica - Aparatos de colocación oleoneumáticos

RIVQUICK® P3000



	Ø									
	2,4*	3,0*	3,2	4,0	4,8	4,8V	5,0	6,0	6,4	6,4V
Alu - Alu - Alu - Allu - Alu					■	■	■	■	■	■
Zinc plated - Acier zingué - Stahl verzinkt Acciaio zincato - Acero cincado					■	■	■	■	■	■
Stainless steel - Inox - Edelstahl - Inox - Inox					■	■	■	■	■	■





 226 032 01000



-  Recommended for RIVQUICK® Varibolt and RIVQUICK® Varilock ø 6.4 mm.
To set RIVQUICK® Varibolt, a specific nosepiece is recommended (see tools part of the catalogue).
-  Recommandé pour les gammes RIVQUICK® Varibolt et RIVQUICK® Varilock ø 6,4 mm.
Pour la pose de rivets RIVQUICK® Varibolt, veuillez utiliser un nez spécifique à verrouillage (voir section pièces détachées - outillage).
-  Empfohlen für RIVQUICK® Varibolt und RIVQUICK® Varilock ø 6,4 mm.
Zum Einbau von RIVQUICK® Varibolt Sondermundstück verwenden (siehe Ersatzteilübersicht).
-  Consigliato per RIVQUICK® Varibolt e RIVQUICK® Varilock ø 6,4 mm.
Per la posa dei rivetti RIVQUICK® Varibolt, utilizzate un nasello speciale (vedere parte pezzi di ricambio/utensil).
-  Recomendada para las gamas RIVQUICK® Varibolt y RIVQUICK® Varilock ø 6,4 mm.
Para la colocación de los remaches RIVQUICK® Varibolt, utilizar las boquillas especiales (ver la información sobre útiles y recambios contenida en este catálogo).

Spare parts / Tooling - Pièces détachées / Outillage - Ersatzteile - Piezzi di ricambio / Atrezzatura - Piezas de recambio / Útiles

				
		RIVQUICK® P1000	RIVQUICK® P2000	RIVQUICK® P3000
Nose piece Embouchure Mundstück Nasello Boquilla	Ø 2,4	226 030 24001*		
	Ø 3,2	226 030 32001*		
	Ø 4,0	226 030 40001		
	Ø 5,0	226 030 50001		
	Ø 6,0		226 031 60001	
	Ø 6,4		226 031 64001	
	Ø 4,8 Varibolt Ø 6,4 Varibolt			226 031 48001
1 set of jaws 3 pieces 1 jeu de mors 3 parties Klemmbackensatz dreiteilig 1 set di 3 morsetti 1 juego de mordazas en 3 partes	Ø 2,4 → Ø 6,4	226 030 00002		

-  *Conversion kit 226 030 00086 is necessary for nose piece ø 2.4 and nose piece ø 3.2 (for stem diameter < 2.0mm)
-  *Le kit de conversion 226 030 00086 est nécessaire pour l'utilisation d'embouchures ø 2,4 et ø 3,2 (pour les diamètres de tige < 2,0 mm)
-  *Umrüstsatz 226 030 00086 ist für die Verwendung von Mundstücken ø 2,4 und ø 3,2 notwendig (Nietdorndurchmesser < 2,0 mm)
-  *Kit di conversione 226 030 00086 necessario per nasello ø 2,4 e nasello ø 3,2 (per diametro dello stelo < 2,0mm)
-  *El kit de conversión 226 030 00086 es necesario para la utilización de las boquillas de ø 2,4 y de ø 3,2 (Para vástago de diametro < 2,0mm)

Accessories - Accessoires - Zubehör - Optional - Opciones



Extended noses Nez de pose allongés Verlängerte Mundstückhalter Estensione nasi Boquillas extendidas		XX = 110 mm
		XX = 160 mm
		XX = 210 mm

RIVQUICK® P1000	RIVQUICK® P2000	RIVQUICK® P3000
226 030 00110	226 031 00110	226 032 00110
226 030 00120	226 031 00120	226 032 00120
226 030 00130	226 031 00130	226 032 00130

Extended stem collector Bol récupérateur de tiges allongées Vergrößerter Nietdornauffangbehälter Estensione raccogliitore chiodo Colector para vástagos largos		226 030 00087
--	--	-------------------------------

Conversion kit for stem $\varnothing < 2$ mm Kit de conversion pour tige $\varnothing < 2$ mm Umrüstsatz für Nietdorn $\varnothing < 2$ mm kit di conversione per chiodo $\varnothing < 2$ mm Kit de conversión para vástago $\varnothing < 2$ mm		226 030 00086
---	--	-------------------------------



		L +10 mm	L +15 mm	L +20 mm	L +25 mm
Extended nose pieces Embouchures allongées Verlängerte Mundstücke Bocchello lunghezza speciale Boquillas extendidas		226 030 24101	226 030 24151	226 030 24201	226 030 24251
	\varnothing 2,4	226 030 32101	226 030 32151	226 030 32201	226 030 32251
	\varnothing 3,2	226 030 40101	226 030 40151	226 030 40201	226 030 40251
	\varnothing 4,0	226 030 50101	226 030 50151	226 030 50201	226 030 50251
	\varnothing 5,0	226 030 60101	226 030 60151	226 030 60201	226 030 60251
	\varnothing 6,0	226 030 64101	226 030 64151	226 030 64201	226 030 64251
\varnothing 6,4					

Dedicated to special rivets with extended mandrels
 Nécessite l'utilisation de rivets avec tige allongée
 Für Sonderblindniete mit verlängertem Nietdorn
 Dedicato a rivetti speciali con mandrini lunghi
 Para remaches especiales con vástagos prolongados.



RIVQUICK® – Battery operated setting tools - Outils de pose à batterie - Akku-Blindnietwerkzeuge -
Apparecchi di posa a batteria - Remachadoras a batería

RIVQUICK® B series

	RIVQUICK® B2000	RIVQUICK® B3000
 Kg	2 000 g	2 100 g
Setting force - Traction - Setzkraft Trazione - Tracción	10 000 N	18 000 N
Tool stroke - Course - Gerätehub Corsa - Recorrido	20 mm	27 mm
	Li-Ion-14,4V-1,4Ah	Li-Ion-14,4V-2,8Ah

- 1/4 turn removable stem collector - Bol récupérateur de tiges démontable 1/4 de tour - Abnehmbarer Nietdorn-Auffangbehälter - Serbatoio recupera chiodi a sgancio rapido - Con recuperador de vástagos

RIVQUICK® B2000

	Ø							
	2,4	3,0	3,2	4,0	4,8	5,0	6,0	6,4
Alu - Alu - Alu - Allu - Alu	■	■	■	■	■	■		
Zinc plated - Acier zingué - Stahl verzinkt Acciaio zincato - Acero cincado	■	■	■	■	■	■	■	■
Stainless steel - Inox - Edelstahl - Inox - Inox	■	■	■	■	■	■		

 **226 040** 01000



RIVQUICK® B3000

	Ø							
	2,4	3,0	3,2	4,0	4,8	5,0	6,0	6,4
Alu - Alu - Alu - Allu - Alu	■	■	■	■	■	■		
Zinc plated - Acier zingué - Stahl verzinkt Acciaio zincato - Acero cincado	■	■	■	■	■	■	■	■
Stainless steel - Inox - Edelstahl - Inox - Inox	■	■	■	■	■	■		

 **226 041** 01000



Spare parts / Tooling - Pièces détachées / Outillage - Ersatzteile - Piezzi di ricambio / Atrezzatura - Piezas de recambio / Útiles



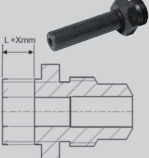



			
		RIVQUICK® B2000	RIVQUICK® B3000
Nose piece Embouchure Mundstück Nasello Boquilla		Ø 2,4	226 040 24001
		Ø 3,2	226 040 32001
		Ø 4,0	226 040 40001
		Ø 5,0	226 040 50001
		Ø 6,0	226 041 60001
		Ø 6,4	226 041 64001
		Ø 4,8 Varibolt	226 041 48002
		Ø 6,4 Varibolt	226 041 64003
1 set of jaws 3 pieces 1 jeu de mors 3 parties Klemmbackensatz dreiteilig 1 set di 3 morsetti 1 juego de mordazas en 3 partes		Ø 2,4 → Ø 6,0	226 040 00004
		Ø 6,4	226 041 00004
Battery Batterie Akku Batteria Bateria		Li-Ion-14,4V-1,4Ah	226 040 00018
		Li-Ion-14,4V-2,8Ah	226 040 00019
Battery charger Chargeur de batterie Ladegerät Caricabatterie Cargador de batería		100-240V~50-60Hz-1A	226 040 00020



		L +15 mm	
Extended nose pieces Embouchures allongées Verlängerte Mundstücke Bocchello lunghezza speciale Boquillas extendidas		Ø 3,2	226 040 32002
		Ø 4,0	226 040 40002
		Ø 5,0	226 040 50002







Dedicated to special rivets with extended mandrels
 Nécessite l'utilisation de rivets avec tige allongée
 Für Sonderblindniete mit verlängertem Nietdorn
 Dedicato a rivetti speciali con mandrini lunghi
 Para remaches especiales con vástagos prolongados.





 Cod.		 Cod.		 Cod.		 Cod.		 Cod.	
220 211 32080	7	221 312 40140	10	221 321 40100	13	221 331 48180	15	221 411 32115	21
220 211 40100	7	221 312 40160	10	221 321 40110	13	221 331 48200	15	221 411 32130	21
220 211 48110	7	221 312 40180	10	221 321 40120	13	221 331 48240	15	221 411 40080	21
220 221 32120	7	221 312 40200	10	221 321 40140	13	221 331 64120	15	221 411 40100	21
220 221 40130	7	221 312 48070	10	221 321 40160	13	221 331 64150	15	221 411 40115	21
220 221 48110	7	221 312 48090	10	221 321 40180	13	221 331 64180	15	221 411 40130	21
220 231 32120	23	221 312 48110	10	221 321 40200	13	221 331 64220	15	221 411 40145	21
220 231 40130	23	221 312 48120	10	221 321 40240	13	221 331 64260	15	221 411 48095	21
220 231 48140	23	221 312 48140	10	221 321 40300	13	221 331 64300	15	221 411 48110	21
220 331 32080	7	221 312 48160	10	221 321 48060	13	221 336 48100	16	221 411 48125	21
220 331 40060	7	221 312 48180	10	221 321 48070	13	221 336 48120	16	221 411 48155	21
220 331 40080	7	221 312 48200	10	221 321 48080	13	221 336 48140	16	221 411 48180	21
220 331 40100	7	221 312 48260	10	221 321 48090	13	221 336 48160	16	221 411 48220	21
220 331 40130	7	221 312 48300	10	221 321 48100	13	221 336 48200	16	221 413 40120	19
220 331 48080	7	221 314 40080	11	221 321 48110	13	221 351 30060	18	221 413 40160	19
220 331 48100	7	221 314 40100	11	221 321 48120	13	221 351 30080	18	221 413 40200	19
220 331 48200	7	221 314 40120	11	221 321 48140	13	221 351 30100	18	221 413 40240	19
220 413 40001	24	221 314 40140	11	221 321 48180	13	221 351 32060	18	221 413 48120	19
220 413 40002	24	221 314 40160	11	221 321 48200	13	221 351 32080	18	221 413 48140	19
220 478 40001	24	221 314 40200	11	221 321 48240	13	221 351 32100	18	221 413 48160	19
220 478 40002	24	221 314 48080	11	221 321 48260	13	221 351 32120	18	221 413 48200	19
220 478 40003	24	221 314 48120	11	221 321 48300	13	221 351 40060	18	221 413 48240	19
220 611 30060	6	221 314 48140	11	221 321 48350	13	221 351 40080	18	221 413 48300	19
220 611 32060	6	221 314 48160	11	221 321 48400	13	221 351 40100	18	221 413 48350	19
220 611 32080	6	221 314 48180	11	221 321 60080	13	221 351 40120	18	221 413 48400	19
220 611 32100	6	221 314 48200	11	221 321 60100	13	221 351 40140	18	221 413 48450	19
220 611 40060	6	221 314 48240	11	221 321 60120	13	221 351 40160	18	221 413 48500	19
220 611 40080	6	221 314 48260	11	221 321 60150	13	221 351 40200	18	221 431 32080	22
220 611 40100	6	221 314 48300	11	221 321 60180	13	221 351 48060	18	221 431 32095	22
220 611 40120	6	221 314 48350	11	221 321 60220	13	221 351 48080	18	221 431 32120	22
220 611 40140	6	221 314 48400	11	221 321 60260	13	221 351 48100	18	221 431 40080	22
220 611 40160	6	221 316 32080	12	221 321 60300	13	221 351 48120	18	221 431 40095	22
220 611 48080	6	221 316 32100	12	221 321 64080	13	221 351 48140	18	221 431 40120	22
220 611 48100	6	221 316 32140	12	221 321 64100	13	221 351 48160	18	221 431 40160	22
220 611 48120	6	221 316 32160	12	221 321 64120	13	221 351 48180	18	221 431 48095	22
220 611 48140	6	221 316 32180	12	221 321 64150	13	221 351 48200	18	221 431 48120	22
220 611 48160	6	221 316 32160	12	221 321 64180	13	221 351 48260	18	221 478 40160	20
220 611 48200	6	221 316 40080	12	221 321 64220	13	221 351 48300	18	221 478 40200	20
220 611 60120	6	221 316 40100	12	221 321 64260	13	221 371 32060	17	221 478 40250	20
220 611 64120	6	221 316 40120	12	221 321 64300	13	221 371 32080	17	221 478 48160	20
221 211 32080	23	221 316 40140	12	221 322 32080	14	221 371 32100	17	221 478 48200	20
221 211 32095	23	221 316 40160	12	221 322 32100	14	221 371 32120	17	221 478 48250	20
221 211 32115	23	221 316 40180	12	221 322 32120	14	221 371 40060	17	221 611 24050	8
221 211 40100	23	221 316 48120	12	221 322 40080	14	221 371 40080	17	221 611 24060	8
221 211 40130	23	221 316 48140	12	221 322 40100	14	221 371 40100	17	221 611 24070	8
221 211 40170	23	221 316 48160	12	221 322 40120	14	221 371 40120	17	221 611 24080	8
221 211 48110	23	221 316 48180	12	221 322 40140	14	221 371 40140	17	221 611 24100	8
221 211 48150	23	221 316 48200	12	221 322 40160	14	221 371 40160	17	221 611 24120	8
221 211 48170	23	221 316 48240	12	221 322 48120	14	221 371 40200	17	221 611 30050	8
221 211 48250	23	221 316 48260	12	221 322 48140	14	221 371 48080	17	221 611 30060	8
221 216 48100	23	221 316 48300	12	221 322 48160	14	221 371 48100	17	221 611 30062	24
221 216 48160	23	221 316 48350	12	221 322 48200	14	221 371 48120	17	221 611 30063	24
221 216 48250	23	221 316 48400	12	221 331 30060	15	221 371 48140	17	221 611 30064	24
221 312 24060	10	221 321 30060	13	221 331 30080	15	221 371 48160	17	221 611 30070	8
221 312 24080	10	221 321 30070	13	221 331 30100	15	221 371 48180	17	221 611 30080	8
221 312 24100	10	221 321 30080	13	221 331 30120	15	221 371 48200	17	221 611 30082	24
221 312 30070	10	221 321 30090	13	221 331 32060	15	221 381 32060	25	221 611 30083	24
221 312 30090	10	221 321 30100	13	221 331 32080	15	221 381 32080	25	221 611 30084	24
221 312 30110	10	221 321 30120	13	221 331 32100	15	221 381 32100	25	221 611 30090	8
221 312 32070	10	221 321 30140	13	221 331 32120	15	221 381 40080	25	221 611 30100	8
221 312 32090	10	221 321 32070	13	221 331 40060	15	221 381 40100	25	221 611 30102	24
221 312 32110	10	221 321 32080	13	221 331 40080	15	221 381 40120	25	221 611 30103	24
221 312 32130	10	221 321 32090	13	221 331 40100	15	221 381 40140	25	221 611 30104	24
221 312 40070	10	221 321 32100	13	221 331 40120	15	221 381 48080	25	221 611 30110	8
221 312 40090	10	221 321 32110	13	221 331 40140	15	221 381 48100	25	221 611 30120	8
221 312 40110	10	221 321 32120	13	221 331 40160	15	221 381 48120	25	221 611 30122	24
221 312 40120	10	221 321 32160	13	221 331 48080	15	221 381 48140	25	221 611 30123	24
221 312 40120	10	221 321 40060	13	221 331 48100	15	221 411 32080	21	221 611 30124	24
		221 321 40070	13	221 331 48120	15	221 411 32095	21	221 611 30140	8
		221 321 40080	13	221 331 48140	15	221 411 32110	21	221 611 30160	8
		221 321 40090	13	221 331 48160	15			221 611 30180	8

 Cod.	
221 611 32050	8
221 611 32060	8
221 611 32062	24
221 611 32063	24
221 611 32064	24
221 611 32070	8
221 611 32080	8
221 611 32082	24
221 611 32083	24
221 611 32084	24
221 611 32090	8
221 611 32100	8
221 611 32102	24
221 611 32103	24
221 611 32104	24
221 611 32110	8
221 611 32120	8
221 611 32122	24
221 611 32123	24
221 611 32124	24
221 611 32140	8
221 611 32160	8
221 611 32180	8
221 611 32200	8
221 611 40050	8
221 611 40060	8
221 611 40070	8
221 611 40072	24
221 611 40073	24
221 611 40074	24
221 611 40080	8
221 611 40082	24
221 611 40083	24
221 611 40084	24
221 611 40090	8
221 611 40092	24
221 611 40093	24
221 611 40094	24
221 611 40100	8
221 611 40102	24
221 611 40103	24
221 611 40104	24
221 611 40110	8
221 611 40112	24
221 611 40113	24
221 611 40114	24
221 611 40120	8
221 611 40122	24
221 611 40123	24
221 611 40124	24
221 611 40140	8
221 611 40142	24
221 611 40143	24
221 611 40144	24
221 611 40160	8
221 611 40162	24
221 611 40163	24
221 611 40164	24
221 611 40180	8
221 611 40182	24
221 611 40183	24
221 611 40184	24
221 611 40200	8
221 611 40202	24
221 611 40203	24
221 611 40204	24
221 611 40220	8
221 611 40240	8
221 611 40260	8
221 611 40280	8
221 611 40300	8
221 611 40350	8
221 611 48060	9
221 611 48070	9
221 611 48072	24

 Cod.	
221 611 48073	24
221 611 48074	24
221 611 48080	9
221 611 48082	24
221 611 48083	24
221 611 48084	24
221 611 48090	9
221 611 48092	24
221 611 48093	24
221 611 48094	24
221 611 48100	9
221 611 48102	24
221 611 48103	24
221 611 48104	24
221 611 48110	9
221 611 48112	24
221 611 48113	24
221 611 48114	24
221 611 48120	9
221 611 48122	24
221 611 48123	24
221 611 48124	24
221 611 48140	9
221 611 48142	24
221 611 48143	24
221 611 48144	24
221 611 48160	9
221 611 48162	24
221 611 48163	24
221 611 48164	24
221 611 48180	9
221 611 48200	9
221 611 48220	9
221 611 48240	9
221 611 48260	9
221 611 48280	9
221 611 48300	9
221 611 48350	9
221 611 48400	9
221 611 48450	9
221 611 48500	9
221 611 50060	9
221 611 50080	9
221 611 50100	9
221 611 50120	9
221 611 50140	9
221 611 50160	9
221 611 50180	9
221 611 50200	9
221 611 50220	9
221 611 50240	9
221 611 50260	9
221 611 50280	9
221 611 50300	9
221 611 60080	9
221 611 60100	9
221 611 60120	9
221 611 60140	9
221 611 60160	9
221 611 60180	9
221 611 60200	9
221 611 60220	9
221 611 60260	9
221 611 60300	9
221 611 60350	9
221 611 60400	9
221 611 64100	9
221 611 64120	9
221 611 64160	9
221 611 64180	9
221 611 64220	9
221 611 64260	9
221 611 64300	9
221 611 64350	9
221 611 64400	9

 Cod.	
221 611 78150	9
221 611 78180	9
221 611 78220	9
221 611 78260	9
221 611 78300	9
221 611 78350	9
221 823 32070	29
221 823 32090	29
221 823 32110	29
221 823 40070	29
221 823 40090	29
221 823 40120	29
221 833 32070	29
221 833 32090	29
221 833 32110	29
221 833 40070	29
221 833 40090	29
221 833 40120	29
221 949 40003	25
221 949 40004	25
221 949 40008	25
223 821 48100	31
223 821 48121	29
223 821 48140	31
223 821 48146	29
223 821 64140	31
223 821 64190	31
223 822 48130	31
223 822 64160	31
223 823 64170	29
223 823 64200	29
223 824 64150	34
223 824 64156	34
223 824 64170	34
223 824 64190	34
223 824 64210	34
223 824 64230	34
223 831 48100	32
223 831 48129	29
223 831 48140	32
223 831 48155	29
223 831 48180	29
223 831 64140	32
223 831 64190	32
223 832 64160	32
223 833 64170	29
223 833 64200	29
225 020 00000	36
225 020 00501	36
225 210 00000	36
225 220 00000	36
226 030 00002	38
226 030 00086	39
226 030 00087	39
226 030 00110	39
226 030 00120	39
226 030 00130	39
226 030 01000	37
226 030 24001	38
226 030 24101	39
226 030 24151	39

 Cod.	
226 030 24201	39
226 030 24251	39
226 030 32001	38
226 030 32101	39
226 030 32151	39
226 030 32201	39
226 030 32251	39
226 030 40001	38
226 030 40101	39
226 030 40151	39
226 030 40201	39
226 030 40251	39
226 030 50001	38
226 030 50101	39
226 030 50151	39
226 030 50201	39
226 030 50251	39
226 030 60101	39
226 030 60151	39
226 030 60201	39
226 030 60251	39
226 030 64101	39
226 030 64151	39
226 030 64201	39
226 030 64251	39
226 031 00110	39
226 031 00120	39
226 031 00130	39
226 031 01000	37
226 031 48001	38
226 031 60001	38
226 031 64001	38
226 032 00110	39
226 032 00120	39
226 032 00130	39
226 032 01000	38
226 032 64001	38
226 040 00004	41
226 040 00018	41
226 040 00019	41
226 040 00020	41
226 040 01000	40
226 040 24001	41
226 040 32001	41
226 040 32002	41
226 040 40001	41
226 040 40002	41
226 040 50001	41
226 040 50002	41
226 041 00004	41
226 041 01000	40
226 041 48002	41
226 041 60001	41
226 041 64001	41
226 041 64003	41

Böllhoff International with companies in:

Argentina
Austria
Brazil
Canada
China
Czech Republic
France
Germany
Hungary
India
Italy
Japan
Mexico
Poland
Romania
Russia
Slovakia
South Korea
Spain
Switzerland
Thailand
Turkey
United Kingdom
USA

Apart from these 24 countries, Böllhoff supports its international customers in other important industrial markets in close partnership with agents and dealers.

Böllhoff Group
Please find your local contact on www.boellhoff.com
or contact us under fasteningtechnology@boellhoff.com

